

2009



Guarnizioni per refrigerazione

- Standard
- Su misura
- Fai da te



Gaskets for refrigeration

- Standard
- Customized
- Do-it-yourself



Dichtungen für Gewerbekälte

- Standard
- Auf Maß
- Selbstbau



Burletes para refrigeración

- Estándar
- A medida
- Hazlo tú mismo



1982

2009





OFFRE TUTTI I TIPI DI GUARNIZIONI PER REFRIGERAZIONE!

In questo catalogo:

a) GUARNIZIONI STANDARD

Sono le nostre guarnizioni già disponibili a magazzino e pronte all'uso, per i modelli attualmente più diffusi. La ricerca è facile: le guarnizioni sono elencate per TIPO DI PROFILO e DIMENSIONE.

b) GUARNIZIONI SU MISURA

Se la misura ricercata non è tra quelle disponibili in elenco, potete richiederci di realizzarla su misura con un minimo d'ordine di 2 pezzi. Basta compilare l'apposito modulo d'ordine a pag. 35 ed inviarlo via fax, oppure ordinarle direttamente dal nostro INTERNET SHOP sul sito www.lfcatering.com (password a richiesta).

c) GUARNIZIONI FAI DA TE

È inoltre possibile acquistare guarnizioni in barre per realizzarle autonomamente nelle misure desiderate. Nel catalogo sono indicati anche tutti gli strumenti occorrenti: cesoie, saldatrice, adesivi ed inserti angolari.



OFFERS ALL KINDS OF GASKETS FOR REFRIGERATION!

In this volume:

a) STANDARD GASKETS

These types of gaskets, suitable to the most common models, are already in stock and ready to use. Searching for them is easy: these gaskets are listed by PROFILE TYPE and DIMENSION.

b) CUSTOMIZED GASKETS

Should the gasket size not be available among those listed, you can ask us to customize it for you, with a minimum order of 2 units. All you need to do is fill out the order form at page 35 and fax it, or order these gaskets directly on-line at www.lfcatering.com (password available upon request).

c) DO-IT-YOURSELF GASKETS

It is also possible to purchase strips of gaskets for an easy do-it-yourself assembly in the desired size. Our catalogues feature all necessary tools: shears, welder, adhesives and elbow inserts.



BIETET ALLE TYPEN VON DICHTUNGEN FÜR GEWERBEKÄLTE AN!

In diesem Katalog:

a) DICHTUNGEN STANDARD

Diese Dichtungen führen wir in Standard Abmessungen am Lager. Für die Suche benötigen Sie nur das Profil und die Außenabmessungen und können dann direkt über unser BtoB unter www.lfcatering.de / www.lfcatering.ch bestellen (Passwort auf Anfrage).

b) DICHTUNGEN AUF MAß

Sind die Abmessungen die Sie benötigen nicht im Standardortiment, fertigen wir diese auch gerne für sie an. Mindestabnahme 2 Stück pro Größe. Entweder verwenden Sie für die Anfrage unser Formular auf Seite 35 oder Sie machen eine Suchanfrage direkt über unser BtoB.

c) SELBSTBAU DICHTUNGEN

Es ist möglich Dichtungen in Stücken einzukaufen und dann die Dichtungen auf Maß selbst zu fertigen. Wir bieten Ihnen alle dazu notwendigen Werkzeuge an.



OFRECE TODOS LOS TIPOS DE BURLETES PARA REFRIGERACIÓN!

En este catálogo:

a) BURLETES ESTÁNDAR

Son nuestros burletes ya disponibles en almacén y listos para enviar, para los modelos actualmente más difundidos. La búsqueda es fácil: los burletes están enumerados por TIPO DE PERFIL y DIMENSIONES.

b) BURLETES A MEDIDA

Si la medida del burlete no está entre aquellos disponibles en el listado, podrá requerirlos para realizarlos a medida en un pedido mínimo de 2 unidades. Basta rellenar el modulo correspondiente de pedido en la pág. 35 y enviarlo vía fax, o pedirlo directamente en nuestro INTERNET SHOP del sitio www.lfcatering.es (contraseña previa petición).

c) BURLETES "HAZLO TÚ MISMO"

Además es posible adquirir los burletes en tiras para realizar de manera autónoma en la medida deseada. En el catálogo están indicados también todas las herramientas necesarias: tijeras, soldadora, adhesivos e inserta ángulos.





Indice generale

General contents

Inhaltsübersicht

Índice general

	Página / Page Seite / Página
Come ordinare le guarnizioni dal nostro INTERNET SHOP How to order gaskets from our INTERNET SHOP Dichtungen in unserem INTERNETSHOP bestellen Como pedir los burletes en nuestra tienda de Internet	2
Elenco dei profili Profiles Profile Listado de perfiles	4
Guarnizioni ad incastro Snap-in gaskets Steckdichtungen Burletes de encastre	6
Guarnizioni ad incastro per abbattitori Snap-in gaskets for blast chillers Steckdichtungen für Schockfroster Burletes de encastre para abatidores	26
Guarnizioni mezzobordo Middle-edged gaskets Dichtungen mit Halbrahmen Burletes de medio borde	28
Modulo d'ordine per guarnizioni su misura Order form for customized gaskets Bestellformular für Dichtungen auf Maß Formulario para pedir burletes a medida	35
Guarnizioni "fai da te" "Do-it-yourself" gaskets "Selbstbau" Dichtungen Burletes para "hazlo tú mismo"	37 39 41 43

ONE STOP SHOP

Guarnizioni... tutte da  !

Per guarnizioni speciali minimo d'ordine 2 pezzi

www.lfcatering.com

(password a richiesta)

Esclusivo motore di ricerca
e ordini on-line per guarnizioni

ONE STOP SHOP

Any kind of gasket at  !

Minimum order amount for customized gaskets: 2 pieces

www.lfcatering.com

(password upon request)

special on-line search function
and order for gaskets

1



● Entrate in **CERCA** e selezionate **RICERCA GUARNIZIONI**

● Click on **SEARCH** and choose **SEARCH BY GASKET TYPE**

● Im **SUCHEN** Modus die **SUCHE NACH DICHTUNGSTYP** auswählen

● Entre en **BUSCAR** y seleccione **BÚSQUEDA BURLETES**

2





● Selezionate il tipo di guarnizione che state cercando:
• TUTTE • AD INCASTRO • MEZZOBORDO

● Select the type of gasket you are looking for:
• ALL • SNAP-IN • MIDDLE-EDGED

● Den gesuchten Dichtungstyp auswählen:
• ALLE • STECKDICHTUNG • MIT HALBRAHMEN

● Seleccione el tipo de burlete que está buscando:
• TODOS • DE ENCASTRE • DE MEDIO BORDE

Approfittate dell'esclusivo
global service  delle guarnizioni!

Take advantage of the exclusive
global service for gaskets offered by  !

ONE STOP SHOP

Kühlraumdichtungen... alle bei  !

Sonderanfertigungen Mindestabnahme 2 Stück je Größe

www.lfcatering.de/.ch

(Passwort auf Anfrage)

einmalige und exklusive Such- und Bestellfunktion für Kühlraumdichtungen

ONE STOP SHOP

¡Burletes... todos en  !

Pedido minimo para burletes a medida: 2 unidades

www.lfcatering.es

(contraseña previa petición)

Exclusivo motor de búsqueda y pedidos on-line para burletes

3

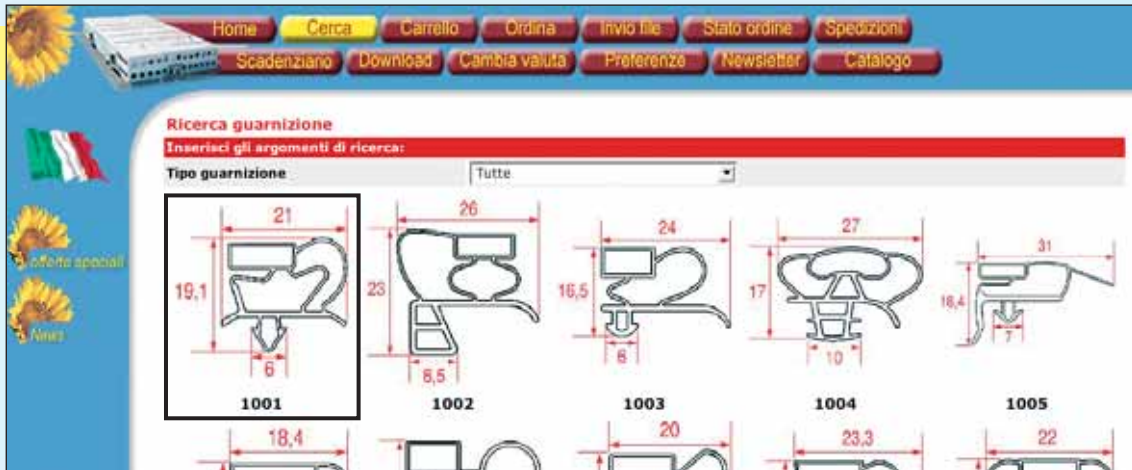

● Selezionate il tipo di guarnizione cliccando direttamente sull'immagine del profilo desiderato

● Das gesuchte Profil auswählen

● Choose the type of gasket by clicking on the picture of the selected profile

● Seleccione el tipo de burlete clickando directamente sobre la imagen del perfil deseado

4

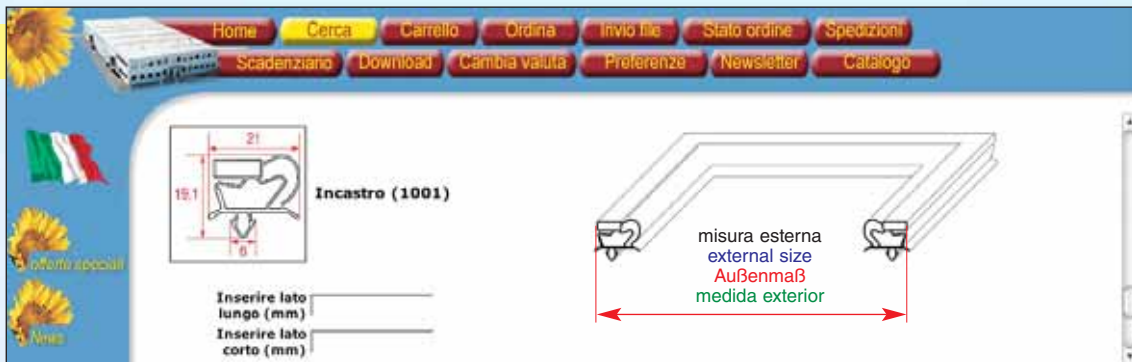

● Inserite le misure del:

- LATO LUNGO
- LATO CORTO

● input the sizes of:

- LONGER SIDE
- SMALLER SIDE

● Die Abmessungen eintragen:

- LANGES MAß
- KURZES MAß

● Inserte la medida del:

- LADO LARGO
- LADO CORTO

5

RISULTATI DELLA RICERCA - SEARCH RESULTS
SUCHERGEBNIS - RESULTADOS DE LA BÚSQUEDA

- a) A CATALOGO = Codice LF
- b) A RICHIESTA = Codice costruttore
- c) NON TROVATO = Compilare il formulario e spedire via e-mail a 

- a) KATALOGWARE = LF Artikelnummer
- b) AUF ANFRAGE = Herstellerartikelnummer
- c) NICHT GEFUNDEN = Bitte das Formular vollständig ausfüllen und an  senden.

- a) IN CATALOGUE = LF code no.
- b) UPON REQUEST = manufacturer code no.
- c) NOT FOUND = fill-in the form and send it by e-mail to: 

- a) EN CATÁLOGO = Código LF
- b) A REQUERIMIENTO = Código fabricante
- c) NO ENCONTRADO = Completar el formulario y mandarlo via e-mail a 

Profitieren auch Sie von diesem Exklusiven Service für Kühlraumdichtungen der  !

¡Aproveche del exclusivo servicio global  de los burletes!

CODICI PROFILI • PROFILE CODES •

GUARNIZIONI AD INCASTRO • SNAP-IN GASKETS

Disegni profili in dimensioni reali (Scala 1:1)

Profiles in real size (drawings to scale 1:1)

Abbildung der Profile in Originalgröße

Perfiles de los diseños en dimensiones verdaderas
(escala de 1:1)

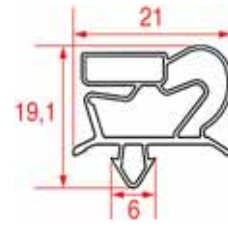

1001 •



1002

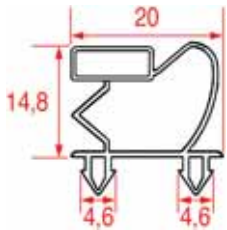

1008 ❖

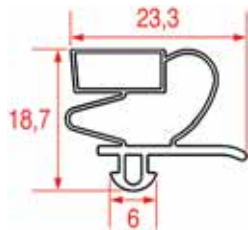

1009 ❖

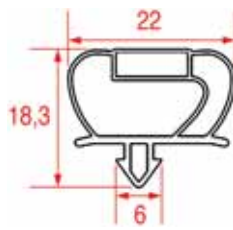

1010 •

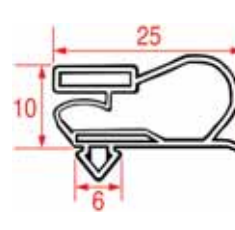

1011 ❖

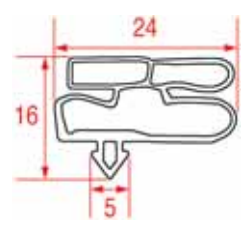

1012 ❖

Per guarniz. su misura vedere **1025**
For customized gaskets see **1025**
Für Dichtungen auf Maß siehe **1025**
Para burletes a medida ver **1025**

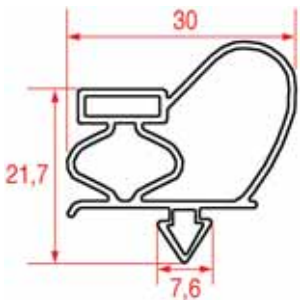

1018 •
IME / Turbo

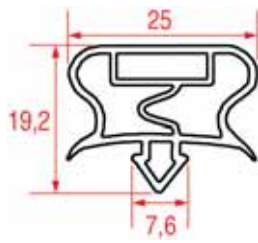

1019 •
IME / Turbo



1020 •
Franke

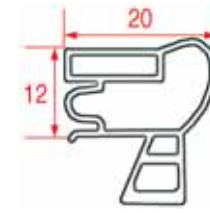

1021
IME / Turbo

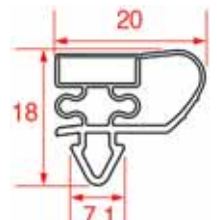

1022
IME / Turbo

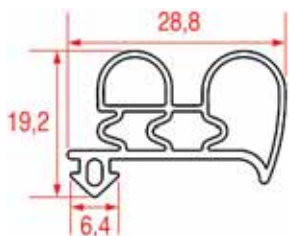

1028 • ❖

NON MAGNETICA
NON MAGNETIC
NICHT MAGNETISCH
NO MAGNÉTICO

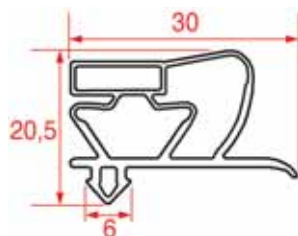

1029

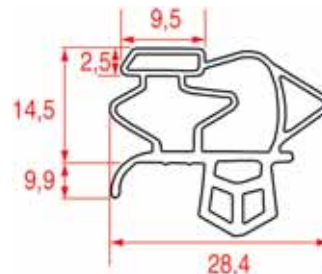

1030 ❖

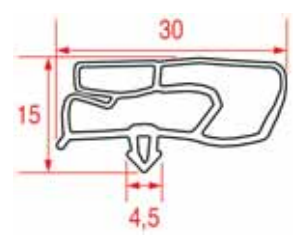

1031 ❖



• Disponibile anche in barre per "fai da te", vedi pag. 37
Also available in lengths for "do-it-yourself", see page 39
Auch in Standardstücken für "Selbstbau" vorhanden, auf Seite 41
Disponibile también en tiras para "hazlo tú mismo", ver pág. 43

❖ Non fornibile su misura
Special size not available
Sonderanfertigung nicht lieferbar
No disponible a medida

DICHTUNGSPROFILE • CÓDIGOS PERFILES

• STECKDICHTUNGEN • BURLETES DE ENCASTRE

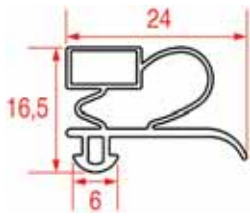

1003 •



1004 ❖
 NON MAGNETICA
 NON MAGNETIC
 NICHT MAGNETISCH
 NO MAGNÉTICO

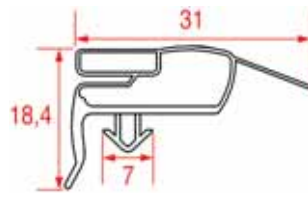

1005 ❖

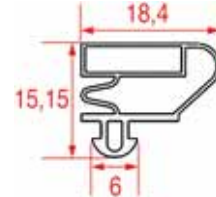

1006

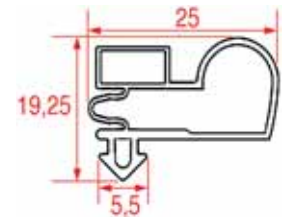

1007 •

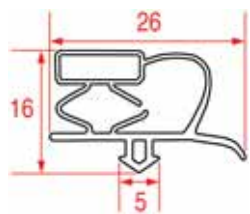

1013 ❖

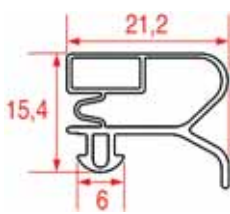

1014 ❖

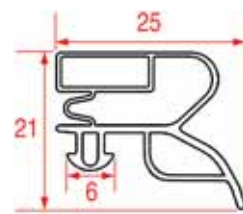

1015 ❖



1016

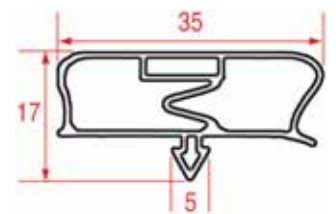

1017 ❖

Per guarniz. su misura vedere **1006** Per guarniz. su misura vedere **1006**
 For customized gaskets see **1006** For customized gaskets see **1006**
 Für Dichtungen auf Maß siehe **1006** Für Dichtungen auf Maß siehe **1006**
 Para burletes a medida ver **1006** Para burletes a medida ver **1006**

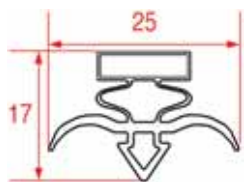

1023 •



1024 •❖

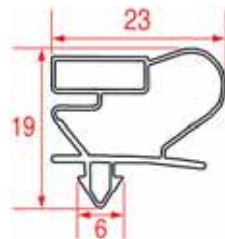

1025

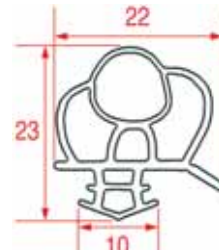

1026 •❖
 NON MAGNETICA
 NON MAGNETIC
 NICHT MAGNETISCH
 NO MAGNÉTICO



1027 •❖

NON MAGNETICA
 NON MAGNETIC
 NICHT MAGNETISCH
 NO MAGNÉTICO

GUARNIZIONI MEZZOBORDO • MIDDLE-EDGED GASKETS DICHTUNGEN MIT HALBRAHMEN • BURLETES DE MEDIO BORDE

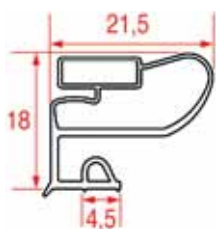

2001 •



2002 •

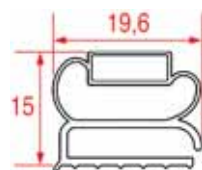

2003 ❖

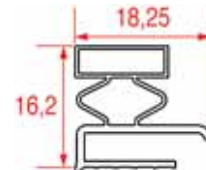

2004 •

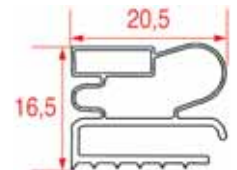

2005 •❖

Per guarniz. su misura vedere **2004**
 For customized gaskets see **2004**
 Für Dichtungen auf Maß siehe **2004**
 Para burletes a medida ver **2004**

GUARNIZIONI AD INCASTRO • SNAP-IN GASKETS STECKDICHTUNGEN • BURLETES DE ENCASTRE

ATTENZIONE

Le guarnizioni sono elencate in ordine crescente di misura, prima il lato maggiore poi il minore.
Tutte le misure indicate sono esterne.

ATTENTION

Gaskets are listed by size in increasing order, first the larger then the smaller side.
All indicated sizes are external.

ACHTUNG

Die Dichtungen sind mit steigendem Maß aufgelistet, zuerst die größere und dann die kleinere Seite.
Es handelt sich immer um das Außenmaß.

ATENCIÓN

Los burletes se enumeran en la orden de aumento de la medida, primero el lado mayor
después el lado menor. Todas las medidas indicadas son externas.

COME MISURARE LE GUARNIZIONI • HOW TO MEASURE GASKETS DICHTUNGEN ABMEßEN • COMO MEDIR LOS BURLETES

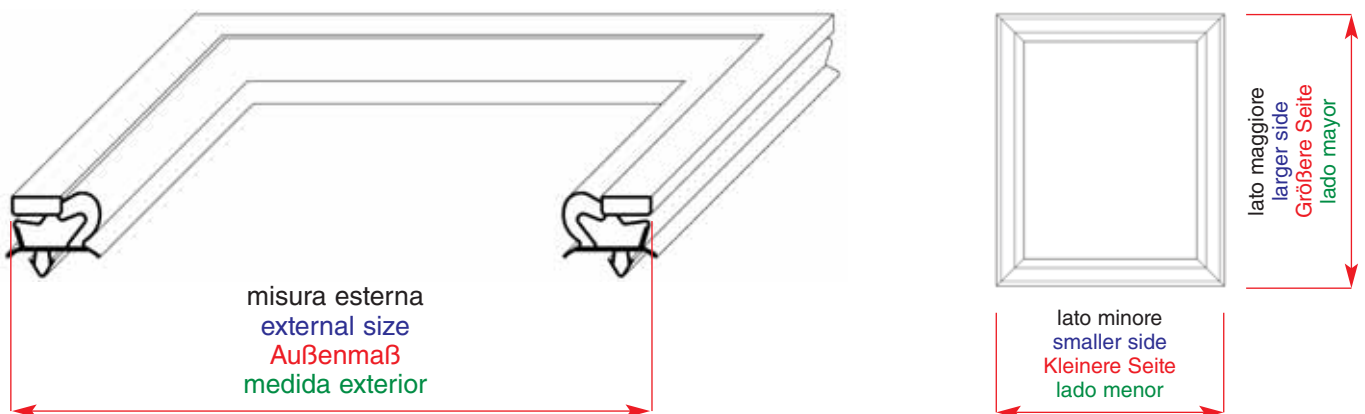

A richiesta forniamo guarnizioni su misura.
Comunicateci il codice del profilo e la misura esterna in mm dei lati.
Attenzione: non si accettano resi di guarnizioni realizzate su misura.

Upon request we supply customized gaskets.
Please, indicate the profile code and the external dimensions of each side expressed in mm.
Attention: customized gaskets cannot be returned.

Auf Anfrage liefern wir Dichtungen auf Maß.
Bitte geben Sie das Dichtungsprofil und das Außenmaß der Seiten in mm an.
Achtung: Rücksendung von angefertigten Dichtungen wird nicht akzeptiert.

A petición proporcionamos burletes a medida.
Comunique el código del perfil y la medida exterior en mm de los lados.
Atención: no aceptamos devoluciones de burletes realizados a medida.



Guarnizioni ad incastro • Snap-in gaskets Steckdichtungen • Burletes de encastre

Cod. Profilo 1001

Profile no. 1001

Profil-Nr. 1001

Perfil nr. 1001

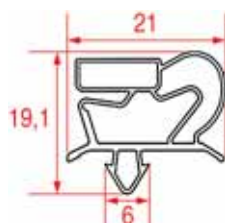

A richiesta forniamo guarnizioni su misura

Upon request we supply customized gaskets

Auf Anfrage liefern wir Dichtungen auf Maß

A petición proporcionamos burletes a medida

Codice LF LF code LF Nr. Cód. LF	Adattabile Suitable for Passend für Adaptable	Dimensioni Dimensions Maße Dimensiones
---	--	---

3186920		325 x 170 mm
★	EMMEPI - 806048	370 x 288 mm
◆	2111403	375 x 210 mm
◆	5028340	377 x 270 mm
	3186923	385 x 155 mm
	3186485	385 x 170 mm
	3186930	385 x 215 mm
	3186921	385 x 275 mm
	3186932	385 x 335 mm
◆	4031693	385 x 374 mm
	3186974 ▲	390 x 200 mm
	3186975 ▲	390 x 305 mm
◆	5026664	395 x 295 mm
	3186924	395 x 385 mm
◆	5019404	396 x 346 mm
★	POLARIS - 14414300149	398 x 164 mm
◆	5027202	398 x 269 mm
★	POLARIS - 14414300359	398 x 374 mm
	3186800	400 x 230 mm
	3186805	402 x 185 mm
	3186803	402 x 295 mm
◆	5032154	405 x 315 mm
◆	5027088	405 x 365 mm
	3186804	405 x 402 mm
	3186836 ▲	407 x 186 mm
	3186835 ▲	407 x 296 mm
	3186544	410 x 155 mm
	3186511	410 x 185 mm
◆	5030955	410 x 205 mm
	3186795	410 x 280 mm
◆	5019431	410 x 367 mm
★	POLARIS - 14414300130	411 x 149 mm
◆	5030177	411 x 160 mm
◆	5030176	411 x 195 mm
★	POLARIS - 14415396183	411 x 203 mm
★	POLARIS - 14415396195	411 x 210 mm
★	POLARIS - 14415396212	411 x 227 mm
★	POLARIS - 14415396253	411 x 268 mm
★	POLARIS - 14415396291	411 x 293 mm
	3186915	415 x 309 mm
	3186916	418 x 199 mm
	3186959	418 x 418 mm
★	POLARIS - 14415396399	419 x 411 mm

Codice LF LF code LF Nr. Cód. LF	Adattabile Suitable for Passend für Adaptable	Dimensioni Dimensions Maße Dimensiones
---	--	---

◆	5031004	420 x 200 mm
★	POLARIS - 14414050205	420 x 220 mm
◆	5025675	420 x 310 mm
◆	5026233	420 x 320 mm
◆	5025400	420 x 402 mm
★	POLARIS - 14412050408	423 x 220 mm
◆	5027955	425 x 230 mm
◆	5025840	430 x 190 mm
◆	5031567	430 x 210 mm
◆	5029589	441 x 304 mm
◆	4088055	441 x 366 mm
	3186538	445 x 195 mm
★	EMMEPI - 808421	445 x 288 mm
	3186539	445 x 305 mm
◆	5011474	465 x 310 mm
	3186844	473 x 415 mm
◆	5028181	477 x 307 mm
◆	2111362	480 x 200 mm
◆	5011453	485 x 303 mm
★	POLARIS - 14415396406	486 x 291 mm
◆	5029347	486 x 339 mm
★	POLARIS - 14414300610	491 x 411 mm
★	POLARIS - 14415465276	495 x 300 mm
◆	5030607	496 x 174 mm
◆	5029915	496 x 184 mm
◆	5030608	496 x 211 mm
◆	5029916	496 x 293 mm
	3186843	500 x 310 mm
★	ZANUSSI - 0A8512	500 x 360 mm
◆	5026705	505 x 460 mm
	3786050	507 x 428 mm
	3186546	510 x 380 mm
	3186652	510 x 410 mm
	3786049	510 x 465 mm
◆	5026575	512 x 420 mm
◆	5030162	515 x 445 mm



▲ A esaurimento scorte verrà sostituito dal profilo **1016**

When stock is finished, replaced by profile **1016**

Wenn ausverkauft wird dieser Art. durch Profil **1016** ersetzt

Hasta agotar existencias, reemplazado por perfil **1016**

◆ Art. LF non gestito a magazzino - LF part no. not in stock - LF Art. Nr. nicht lagermäßig geführt - Art. LF no presente en almacén

★ A richiesta - Upon request - Auf Anfrage - A petición



Cod. Profilo 1001

Profile no. 1001

Profil-Nr. 1001

Perfil nr. 1001

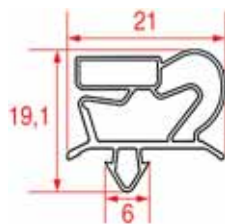

A richiesta forniamo guarnizioni su misura

Upon request we supply customized gaskets

Auf Anfrage liefern wir Dichtungen auf Maß

A petición proporcionamos burletes a medida

Codice LF	Adattabile	Dimensioni
LF code	Suitable for	Dimensions
LF Nr.	Passend für	Maße
Cód. LF	Adaptable	Dimensiones

♦ 5030609		530 x 380 mm
♦ 5025839		530 x 390 mm
3186842		530 x 415 mm
♦ 5028571		545 x 475 mm
3186545		555 x 420 mm
3186922		580 x 385 mm
3186796		580 x 410 mm
♦ 5029443		580 x 470 mm
3786170		584 x 398 mm
♦ 5031856		593 x 411 mm
♦ 5025177		595 x 420 mm
♦ 5027472		595 x 435 mm
3186484		595 x 465 mm
3186931		600 x 385 mm
♦ 5032282		600 x 475 mm
♦ 5025838		610 x 440 mm
♦ 5026798		610 x 480 mm
♦ 5025852		615 x 410 mm
3186905		615 x 425 mm
3186906		615 x 500 mm
3186977		620 x 305 mm
♦ 5026349		620 x 370 mm
♦ 5021739		620 x 407 mm
♦ 5022276		620 x 415 mm
★	EMMEPI - 807584	620 x 445 mm
♦ 2101114		620 x 470 mm
♦ 5031277		620 x 496 mm
♦ 5031807		620 x 515 mm
★	EMMEPI - 79M0143	620 x 590 mm
★	POLARIS - 14416451603	621 x 549 mm
★	POLARIS - 14416070186	622 x 201 mm
♦ 5030751		622 x 421 mm
♦ 5025540		625 x 390 mm
♦ 5031058		625 x 485 mm
♦ 5025674		626 x 402 mm
3186834 ▲		626 x 407 mm
♦ 5027987		627 x 441 mm
3186973 ▲		630 x 390 mm
3186801		630 x 405 mm
3186869		630 x 420 mm
3186537		630 x 445 mm
♦ 5031017		630 x 465 mm
3186868		630 x 505 mm
3186802		635 x 480 mm
3186833 ▲		635 x 590 mm
3186978		635 x 620 mm

Codice LF	Adattabile	Dimensioni
LF code	Suitable for	Dimensions
LF Nr.	Passend für	Maße
Cód. LF	Adaptable	Dimensiones

3186981		640 x 418 mm
3186832 ▲		640 x 430 mm
3186982		640 x 460 mm
3186752		640 x 480 mm
3186983		640 x 501 mm
♦ 5028822		641 x 486 mm
♦ 5026449		643 x 411 mm
3186838		650 x 490 mm
♦ 5000180		660 x 415 mm
♦ 5032153		665 x 405 mm
♦ 5032220		675 x 245 mm
♦ 5025988		680 x 425 mm
3186985		690 x 220 mm
♦ 5031838		690 x 585 mm
♦ 5027657		693 x 412 mm
♦ 5029348		693 x 486 mm
3186986		695 x 505 mm
♦ 5031405		703 x 395 mm
♦ 5029867		708 x 643 mm
♦ 5032140		715 x 640 mm
★	POLARIS - 14415600710	725 x 575 mm
♦ 5028536		730 x 685 mm
★	ZANUSSI - 083675	735 x 527 mm
★	ZANUSSI - 083662	735 x 650 mm
3186929		735 x 660 mm
♦ 5030765		740 x 615 mm
♦ 5022953		740 x 640 mm
3186898		740 x 660 mm
♦ 5031848		745 x 425 mm
♦ 5030127		745 x 675 mm
3186547		750 x 610 mm
3186862		750 x 660 mm
3186972 ▲		750 x 690 mm
♦ 4083823		760 x 640 mm
3186773		762 x 523 mm
3186826		765 x 665 mm
3186934 ▲		770 x 670 mm
3186987		775 x 695 mm
3186904		780 x 680 mm
3186941		780 x 685 mm
3186979		784 x 676 mm
3186828		790 x 770 mm
★	POLARIS - 14410000000	795 x 555 mm
♦ 4083749		827 x 735 mm
★	ART SERF - 2311020	890 x 510 mm
★	ART SERF - 2321000	915 x 895 mm





Guarnizioni ad incastro • Snap-in gaskets Steckdichtungen • Burletes de encastre

Cod. Profilo 1001

Profile no. 1001

Profil-Nr. 1001

Perfil nr. 1001

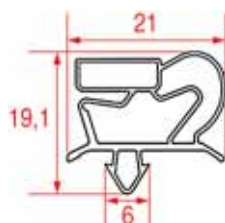

A richiesta forniamo guarnizioni su misura

Upon request we supply customized gaskets

Auf Anfrage liefern wir Dichtungen auf Maß

A petición proporcionamos burletes a medida

Codice LF LF code LF Nr. Cód. LF	Adattabile Suitable for Passend für Adaptable	Dimensioni Dimensions Maße Dimensiones
---	--	---

◆ 5029503		970 x 645 mm
◆ 5026456		1050 x 680 mm
3186988		1050 x 695 mm
3186831 ▲		1190 x 550 mm
◆ 5025323		1440 x 640 mm
◆ 5030217		1450 x 580 mm
3186984		1470 x 570 mm
◆ 4082081		1474 x 694 mm
3186903		1480 x 580 mm
3186902		1485 x 635 mm
◆ 5027280		1500 x 500 mm
◆ 5025315		1500 x 600 mm
◆ 5026274		1500 x 630 mm
◆ 5008139		1500 x 675 mm
◆ 5028922		1506 x 798 mm
◆ 5027089		1515 x 685 mm
◆ 5029610		1520 x 820 mm
◆ 5028308		1523 x 642 mm
3186971 ▲		1525 x 690 mm
★ ZANUSSI - 084137		1526 x 478 mm
3186928		1530 x 660 mm
◆ 4083742		1532 x 528 mm
◆ 5028255		1540 x 640 mm
3186897		1540 x 660 mm
3186753		1540 x 680 mm
◆ 5019942		1541 x 627 mm
◆ 5028726		1545 x 640 mm
3186861		1550 x 660 mm
3186780		1555 x 655 mm
◆ 4083851		1560 x 650 mm
◆ 5026814		1560 x 700 mm
3186729		1565 x 680 mm
3186825		1568 x 670 mm
3186827		1568 x 790 mm
◆ 5026034		1570 x 500 mm
3186935 ▲		1570 x 670 mm

Codice LF LF code LF Nr. Cód. LF	Adattabile Suitable for Passend für Adaptable	Dimensioni Dimensions Maße Dimensiones
---	--	---

3186549		1574 x 614 mm
3186728		1575 x 615 mm
★ POLARIS - 14414991559		1583 x 523 mm
◆ 5031999		1585 x 650 mm
3186901		1590 x 680 mm
3186980		1594 x 676 mm
3186940		1600 x 685 mm
3186989		1600 x 695 mm
◆ 5032001		1605 x 530 mm
◆ 5032000		1605 x 650 mm
3186626		1610 x 605 mm
3186548		1622 x 660 mm
◆ 5030324		1640 x 730 mm
◆ 5028018		1685 x 705 mm
◆ 5028675		1695 x 615 mm
◆ 4087824		1705 x 663 mm
◆ 40A9750		1720 x 610 mm
◆ 40A9180		1805 x 740 mm
3186748		1838 x 638 mm
3186749		1838 x 733 mm
◆ 2101115		1840 x 675 mm
★ POLARIS - 14417321827		1842 x 747 mm
◆ 5031937 (Tre lati - Three sides - Drei Seiten - Tres lados)		1850 x 840 x 1850 mm
◆ 5021685		1862 x 751 mm
3186957		1865 x 745 mm
◆ 5030038		1870 x 730 mm
◆ 4084890		1880 x 865 mm
◆ 5025663		1900 x 760 mm
3186850		1910 x 760 mm
◆ 2101084		2440 x 810 mm

▲ A esaurimento scorte verrà sostituito dal profilo **1016**

When stock is finished, replaced by profile **1016**

Wenn ausverkauft wird dieser Art. durch Profil **1016** ersetzt

Hasta agotar existencias, reemplazado por perfil **1016**

Disponibile anche in barre per "fai da te", cod. **3186874** vedi pag. 37

Also available in lengths for "do-it-yourself", LF code no. **3186874** see page 39

Auch in Standardstücken für "Selbstbau" vorhanden, LF Art. Nr. **3186874** auf Seite 41

Disponibles también en tiras para "hazlo tú mismo" cód. **3186874** ver página 43

- ◆ Art. LF non gestito a magazzino - LF part no. not in stock - LF Art. Nr. nicht lagermäßig geführt - Art. LF no presente en almacén
- ★ A richiesta - Upon request - Auf Anfrage - A petición



Cod. Profilo 1002

Profile no. 1002

Profil-Nr. 1002

Perfil nr. 1002

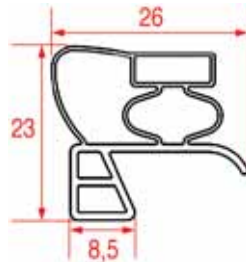

A richiesta forniamo guarnizioni su misura

Upon request we supply customized gaskets

Auf Anfrage liefern wir Dichtungen auf Maß

A petición proporcionamos burletes a medida

Codice LF LF code LF Nr. Cód. LF	Adattabile Suitable for Passend für Adaptable	Dimensioni Dimensions Maße Dimensiones
◆ 5000729		390 x 235 mm
3186955		395 x 300 mm
3186954		620 x 395 mm
3186091		765 x 670 mm

Codice LF LF code LF Nr. Cód. LF	Adattabile Suitable for Passend für Adaptable	Dimensioni Dimensions Maße Dimensiones
3186090		1560 x 670 mm
◆ 5026239		1575 x 750 mm
◆ 5031107		1670 x 670 mm

Cod. Profilo 1003

Profile no. 1003

Profil-Nr. 1003

Perfil nr. 1003

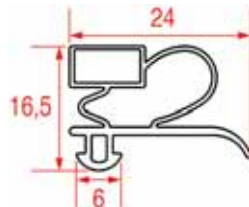

A richiesta forniamo guarnizioni su misura

Upon request we supply customized gaskets

Auf Anfrage liefern wir Dichtungen auf Maß

A petición proporcionamos burletes a medida

Codice LF LF code LF Nr. Cód. LF	Adattabile Suitable for Passend für Adaptable	Dimensioni Dimensions Maße Dimensiones
◆ 5030769		380 x 295 mm
◆ 5030325		390 x 320 mm
◆ 5030326		420 x 180 mm
◆ 5031796		495 x 305 mm
◆ 5030772		525 x 365 mm
◆ 5030773		525 x 455 mm
◆ 5031899		605 x 500 mm
◆ 5030770		610 x 380 mm
◆ 5030327		610 x 600 mm
◆ 5027205		620 x 370 mm
◆ 5027588		620 x 520 mm
3186911		665 x 510 mm
◆ 5026308		715 x 485 mm
3186751		735 x 680 mm
3186095		755 x 665 mm

Codice LF LF code LF Nr. Cód. LF	Adattabile Suitable for Passend für Adaptable	Dimensioni Dimensions Maße Dimensiones
◆ 5031040		755 x 685 mm
3186908		770 x 665 mm
◆ 5030771		845 x 395 mm
◆ 5030045		1360 x 630 mm
3186909		1466 x 618 mm
3186910		1490 x 590 mm
◆ 40A8648		1518 x 684 mm
◆ 5029539		1550 x 370 mm
◆ 5031039		1550 x 685 mm
3186089		1560 x 665 mm
3186907		1570 x 663 mm
3186725		1613 x 647 mm
◆ 5028269		1680 x 925 mm
◆ 5030638		1685 x 665 mm
◆ 5029501		2035 x 835 mm

Disponibile anche in barre per "fai da te", cod. **3186876** vedi pag. 37

Also available in lengths for "do-it-yourself", LF code no. **3186876** see page 39

Auch in Standardstücken für "Selbstbau" vorhanden, LF Art. Nr. **3186876** auf Seite 41

Disponibles también en tiras para "hazlo tú mismo" cód. **3186876** ver página 43

- ◆ Art. LF non gestito a magazzino - LF part no. not in stock - LF Art. Nr. nicht lagermäßig geführt - Art. LF no presente en almacén
- ★ A richiesta - Upon request - Auf Anfrage - A petición



Guarnizioni ad incastro • Snap-in gaskets Steckdichtungen • Burletes de encastre

Cod. Profilo 1004 *NON MAGNETICA*

Profile no. 1004 *NOT MAGNETIC*

Profil-Nr. 1004 *NICHT MAGNETISCH*

Perfil nr. 1004 *NO MAGNÉTICO*

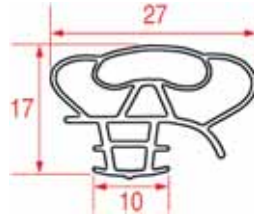

Non fornibile su misura

Special size not available

Sonderanfertigung nicht lieferbar

No disponible a medida

Codice LF	Adattabile	Dimensioni
LF code	Suitable for	Dimensions
LF Nr.	Passend für	Maße
Cód. LF	Adaptable	Dimensiones

3186942		1270 x 544 mm
★ OCEAN		1420 x 605 mm

Codice LF	Adattabile	Dimensioni
LF code	Suitable for	Dimensions
LF Nr.	Passend für	Maße
Cód. LF	Adaptable	Dimensiones

3186945		1550 x 544 mm
---------	--	---------------

Cod. Profilo 1005

Profile no. 1005

Profil-Nr. 1005

Perfil nr. 1005

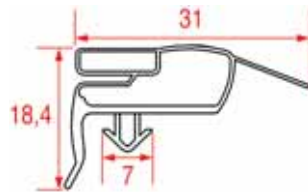

Non fornibile su misura

Special size not available

Sonderanfertigung nicht lieferbar

No disponible a medida

Codice LF	Adattabile	Dimensioni
LF code	Suitable for	Dimensions
LF Nr.	Passend für	Maße
Cód. LF	Adaptable	Dimensiones

◆ 40A9150		506 x 425 mm
3186600		685 x 590 mm
3786242		700 x 655 mm
3186588		723 x 658 mm
3186590		724 x 699 mm
3186966		750 x 690 mm
◆ 2110805		1000 x 525 mm
3186744		1445 x 556 mm
3786215		1490 x 675 mm
3786216		1500 x 660 mm
3186845		1515 x 685 mm
◆ 5028186		1519 x 626 mm
◆ 5028929		1525 x 631 mm
3186741		1525 x 631 mm
3186591		1538 x 698 mm
3186589		1539 x 659 mm
3186651		1539 x 695 mm
3186599		1550 x 685 mm
3186965		1550 x 690 mm
3186933		1570 x 665 mm
◆ 2101228		1627 x 518 mm
3786180		1640 x 705 mm
3186745		1695 x 556 mm
3186505		1695 x 600 mm
3186507		1700 x 612 mm
3186746		1700 x 731 mm
◆ 5026682		1700 x 740 mm

Codice LF	Adattabile	Dimensioni
LF code	Suitable for	Dimensions
LF Nr.	Passend für	Maße
Cód. LF	Adaptable	Dimensiones

Grigio - Grey - Grau - Gris

★	MONDIAL ELITE - 4612102	819 x 556 mm
★	MONDIAL ELITE - 4612103	819 x 731 mm
★	MONDIAL ELITE - 4612042	1242 x 696 mm
★	MONDIAL ELITE - 4612039	1540 x 736 mm
★	MONDIAL ELITE - 4612040	1627 x 511 mm

Bianco - White - Weiß - Blanco

★	MONDIAL ELITE - 4612121	819 x 556 mm
★	MONDIAL ELITE - 4612122	819 x 731 mm
★	MONDIAL ELITE - 4612114	1627 x 511 mm
★	MONDIAL ELITE - 4112115	1627 x 696 mm



Cod. Profilo 1006

Profile no. 1006

Profil-Nr. 1006

Perfil nr. 1006



A richiesta forniamo guarnizioni su misura

Upon request we supply customized gaskets

Auf Anfrage liefern wir Dichtungen auf Maß

A petición proporcionamos burletes a medida

Codice LF LF code LF Nr. Cód. LF	Adattabile Suitable for Passend für Adaptable	Dimensioni Dimensions Maße Dimensiones
---	--	---

◆ 5027281		390 x 195 mm
◆ 5004050		390 x 310 mm
◆ 5028301		395 x 163 mm
◆ 5028302		395 x 273 mm
◆ 5031813		405 x 290 mm
◆ 5026502		415 x 290 mm
3786228		425 x 182 mm
3786227		425 x 295 mm
◆ 5030182		430 x 285 mm
◆ 5032279		434 x 198 mm
◆ 5032280		434 x 307 mm
3186814		461 x 181 mm
3186815		461 x 279 mm
★	EMMEPI - 828289	462 x 194 mm
◆ 5026325		462 x 309 mm
★	EMMEPI - 828431	462 x 418 mm
◆ 5029831		490 x 455 mm
3186816		514 x 456 mm
◆ 5025110		565 x 365 mm
◆ 2111479		570 x 260 mm
◆ 2111478		580 x 450 mm
◆ 5030551		590 x 290 mm
3186813		592 x 462 mm
3186812		592 x 537 mm
◆ 5026569		603 x 450 mm
◆ 5029151		605 x 295 mm
◆ 5028793		612 x 295 mm
3186709		614 x 434 mm
◆ 5026851		615 x 310 mm
3786226		620 x 425 mm
3786225		620 x 485 mm
◆ 5026506		625 x 415 mm
◆ 5027282		630 x 390 mm
◆ 2111477		650 x 450 mm
◆ 5008155		659 x 462 mm
◆ 5004044		663 x 390 mm
3186864		670 x 490 mm

Codice LF LF code LF Nr. Cód. LF	Adattabile Suitable for Passend für Adaptable	Dimensioni Dimensions Maße Dimensiones
---	--	---

◆ 2111476		680 x 580 mm
◆ 5028030		690 x 490 mm
◆ 5032141		730 x 650 mm
3286060		741 x 662 mm
3786224		741 x 669 mm
◆ 5031860		745 x 675 mm
◆ 2111474		750 x 650 mm
3186811		757 x 666 mm
3186884		760 x 690 mm
3186808		767 x 656 mm
3286059		1136 x 536 mm
3186885		1320 x 632 mm
◆ 2111473		1450 x 650 mm
◆ 5028859		1475 x 625 mm
◆ 5031245		1483 x 650 mm
◆ 5011503		1520 x 690 mm
◆ 5027406		1551 x 651 mm
3786223		1552 x 669 mm
3286061		1555 x 662 mm
3186810		1563 x 666 mm
3186883		1570 x 690 mm
◆ 5031178		1575 x 645 mm
3286062		1581 x 521 mm
3186807		1585 x 656 mm
3186809		1588 x 629 mm
◆ 5000077		1590 x 690 mm
◆ 5029930		1600 x 640 mm
◆ 5029671		1600 x 660 mm
◆ 5003756		1610 x 712 mm
3186958		1612 x 688 mm
◆ 5025316		1615 x 605 mm
◆ 5029829		1630 x 790 mm
◆ 5025265		1635 x 715 mm
◆ 4087865		1697 x 675 mm
◆ 5030904		1850 x 860 mm
◆ 5029568		1866 x 749 mm

◆ Art. LF non gestito a magazzino - LF part no. not in stock - LF Art. Nr. nicht lagermäßig geführt - Art. LF no presente en almacén
 ★ A richiesta - Upon request - Auf Anfrage - A petición



Cod. Profilo 1007

Profile no. 1007

Profil-Nr. 1007

Perfil nr. 1007

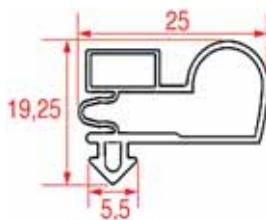

A richiesta forniamo guarnizioni su misura

Upon request we supply customized gaskets

Auf Anfrage liefern wir Dichtungen auf Maß

A petición proporcionamos burletes a medida

<i>Codice LF</i>	<i>Adattabile</i>	<i>Dimensioni</i>
<i>LF code</i>	<i>Suitable for</i>	<i>Dimensions</i>
<i>LF Nr.</i>	<i>Passend für</i>	<i>Maße</i>
<i>Cód. LF</i>	<i>Adaptable</i>	<i>Dimensiones</i>

◆ 5030966	385 x 195 mm
◆ 5030968	405 x 385 mm
◆ 5028968	411 x 313 mm
3786052	420 x 290 mm
◆ 5024886	420 x 392 mm
◆ 5024885	430 x 285 mm
◆ 5024881	430 x 410 mm
◆ 5024884	435 x 180 mm
◆ 5024880	435 x 200 mm
◆ 5028153	485 x 335 mm
◆ 5028154	485 x 420 mm
3186554	560 x 425 mm
◆ 5026714	590 x 430 mm
◆ 5030967	615 x 385 mm
◆ 5030637	615 x 470 mm
3786051	620 x 520 mm
3186556	630 x 425 mm
3186555	640 x 425 mm
◆ 5028967	660 x 411 mm
◆ 5028766	670 x 420 mm
3186882	750 x 655 mm
◆ 5025429	760 x 490 mm
◆ 5028874	760 x 505 mm
◆ 5029461	760 x 595 mm

<i>Codice LF</i>	<i>Adattabile</i>	<i>Dimensioni</i>
<i>LF code</i>	<i>Suitable for</i>	<i>Dimensions</i>
<i>LF Nr.</i>	<i>Passend für</i>	<i>Maße</i>
<i>Cód. LF</i>	<i>Adaptable</i>	<i>Dimensiones</i>

3186917	760 x 665 mm
3186963	770 x 665 mm
◆ 5031118	770 x 670 mm
◆ 5019053	771 x 770 mm
◆ 5028667	830 x 210 mm
◆ 5027773	875 x 685 mm
◆ 5028155	878 x 872 mm
3186913	1336 x 666 mm
3186964	1365 x 665 mm
3186654	1422 x 588 mm
3186653	1425 x 660 mm
◆ 5030046	1474 x 627 mm
◆ 5028639	1520 x 640 mm
3186881	1550 x 655 mm
◆ 2101161	1552 x 660 mm
3186970	1565 x 664 mm
◆ 2111581	1570 x 770 mm
◆ 5030900	1580 x 775 mm
3186557	1600 x 670 mm
◆ 2110850	1630 x 770 mm
◆ 5029836	1900 x 800 mm
◆ 5027527	1920 x 955 mm
◆ 5027528	1950 x 955 mm

Disponibile anche in barre per "fai da te", cod. **3186767** vedi pag. 37

Also available in lengths for "do-it-yourself", LF code no. **3186767** see page 39

Auch in Standardstücken für "Selbstbau" vorhanden, LF Art. Nr. **3186767** auf Seite 41

Disponibles también en tiras para "hazlo tú mismo" cód. **3186767** ver página 43



Cod. Profilo 1008

Profile no. 1008

Profil-Nr. 1008

Perfil nr. 1008

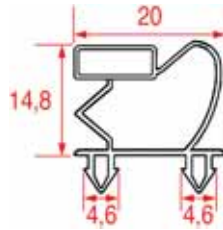

Non fornibile su misura

Special size not available

Sonderanfertigung nicht lieferbar

No disponible a medida

Codice LF	Adattabile	Dimensioni
LF code	Suitable for	Dimensions
LF Nr.	Passend für	Maße
Cód. LF	Adaptable	Dimensiones

3186879 738 x 655 mm

Codice LF	Adattabile	Dimensioni
LF code	Suitable for	Dimensions
LF Nr.	Passend für	Maße
Cód. LF	Adaptable	Dimensiones

3186878 1540 x 655 mm

Cod. Profilo 1009

Profile no. 1009

Profil-Nr. 1009

Perfil nr. 1009



Per guarniz. su misura vedere **Cod. Profilo 1025**

For customized gaskets see **Profile no. 1025**

Für Dichtungen auf Maß siehe **Profil-Nr. 1025**

Para burletes a medida ver **Perfil nr. 1025**

Codice LF	Adattabile	Dimensioni
LF code	Suitable for	Dimensions
LF Nr.	Passend für	Maße
Cód. LF	Adaptable	Dimensiones

- ◆ 5027630 380 x 365 mm
- 3186943 385 x 150 mm
- 3186944 385 x 260 mm
- ◆ 5008142 442 x 255 mm
- 3186946 580 x 385 mm
- 3186918 625 x 390 mm
- 3186707 845 x 659 mm
- ◆ 2101072 1500 x 550 mm

Codice LF	Adattabile	Dimensioni
LF code	Suitable for	Dimensions
LF Nr.	Passend für	Maße
Cód. LF	Adaptable	Dimensiones

- ◆ 40A8359 1565 x 670 mm
- 3186726 1600 x 800 mm
- 3186701 1675 x 1349 mm
- 3186702 1679 x 799 mm
- 3186703 1775 x 749 mm
- 3186704 1845 x 749 mm
- 3186705 1875 x 999 mm
- 3186706 1945 x 999 mm



Guarnizioni ad incastro • Snap-in gaskets Steckdichtungen • Burletes de encastre

Cod. Profilo 1010

Profile no. 1010

Profil-Nr. 1010

Perfil nr. 1010

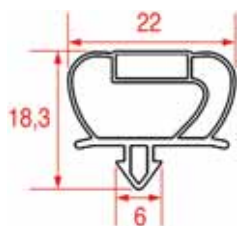

A richiesta forniamo guarnizioni su misura

Upon request we supply customized gaskets

Auf Anfrage liefern wir Dichtungen auf Maß

A petición proporcionamos burletes a medida

Codice LF LF code LF Nr. Cód. LF	Adattabile Suitable for Passend für Adaptable	Dimensioni Dimensions Maße Dimensiones
---	--	---

♦ 5026058		395 x 172 mm
♦ 5026059		395 x 203 mm
♦ 5026060		395 x 295 mm
♦ 5028275		395 x 310 mm
★	EMMEPI - 827432	407 x 175 mm
★	EMMEPI - 827431	407 x 211 mm
♦ 5032285		410 x 225 mm
★	EMMEPI - 827433	420 x 407 mm
♦ 5027402		425 x 285 mm
♦ 5026082		425 x 325 mm
♦ 5026083		445 x 425 mm
♦ 5026571		452 x 305 mm
♦ 5031687		510 x 320 mm
♦ 5032288		540 x 315 mm
♦ 5032287		540 x 405 mm
♦ 5031402		545 x 430 mm
★	EMMEPI - 827364	567 x 210 mm
★	EMMEPI - 827365	567 x 331 mm
★	EMMEPI - 827363	567 x 454 mm
♦ 5026061		595 x 395 mm
♦ 5026335		595 x 435 mm
3786157		605 x 425 mm
♦ 5022763		608 x 590 mm
♦ 5026570		632 x 452 mm
♦ 5028276		640 x 395 mm
♦ 5031688		660 x 510 mm
★	EMMEPI - 827366	676 x 567 mm
★	EMMEPI - 827211	691 x 234 mm
★	EMMEPI - 827212	691 x 369 mm
★	EMMEPI - 827213	691 x 505 mm
♦ 5032286		710 x 410 mm

Codice LF LF code LF Nr. Cód. LF	Adattabile Suitable for Passend für Adaptable	Dimensioni Dimensions Maße Dimensiones
---	--	---

3186071		730 x 710 mm
★	EMMEPI - 827360	750 x 691 mm
♦ 5031871		760 x 195 mm
♦ 5026084		790 x 525 mm
♦ 5026191		1095 x 1000 mm
★	EMMEPI - 827632	1429 x 567 mm
♦ 5030857		1490 x 710 mm
3186077		1500 x 710 mm
3186074		1550 x 660 mm
♦ 5031510		1560 x 690 mm
♦ 5027956		1565 x 610 mm
3186076		1570 x 670 mm
♦ 5016132		1595 x 710 mm
♦ 5028545		1760 x 840 mm
♦ 5025035		1860 x 727 mm
♦ 5026125	(Tre lati - Three sides - Drei Seiten - Tres lados)	1890 x 1005 x 1890 mm
♦ 5030044	(Tre lati - Three sides - Drei Seiten - Tres lados)	1905 x 870 x 1905 mm
♦ 5026191		1905 x 1000 mm
♦ 5030942	(Tre lati - Three sides - Drei Seiten - Tres lados)	1920 x 855 x 1920 mm
♦ 2111480		1930 x 960 mm
♦ 5029500		1950 x 680 mm
♦ 5027292		2000 x 760 mm
3186829	(Tre lati - Three sides - Drei Seiten - Tres lados)	2000 x 765 x 2000 mm
3186830	(Tre lati - Three sides - Drei Seiten - Tres lados)	2000 x 1015 x 2000 mm
♦ 5028860		2065 x 1075 mm
♦ 5027731		2080 x 850 mm

Disponibile anche in barre per "fai da te", cod. **3186877** vedi pag. 37

Also available in lengths for "do-it-yourself", LF code no. **3186877** see page 39

Auch in Standardstücken für "Selbstbau" vorhanden, LF Art. Nr. **3186877** auf Seite 41

Disponibles también en tiras para "hazlo tú mismo" cód. **3186877** ver página 43

- ♦ Art. LF non gestito a magazzino - LF part no. not in stock - LF Art. Nr. nicht lagermäßig geführt - Art. LF no presente en almacén
- ★ A richiesta - Upon request - Auf Anfrage - A petición



Cod. Profilo 1011

Profile no. 1011

Profil-Nr. 1011

Perfil nr. 1011

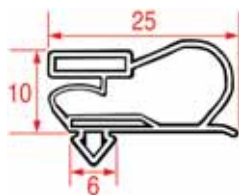

Non fornibile su misura

Special size not available

Sonderanfertigung nicht lieferbar

No disponible a medida

Codice LF	Adattabile	Dimensioni
LF code	Suitable for	Dimensions
LF Nr.	Passend für	Maße
Cód. LF	Adaptable	Dimensiones

3186716		1390 x 585 mm
3186724		1391 x 634 mm
♦ 5029081		1445 x 570 mm
♦ 5031363		1515 x 711 mm
♦ 5028016		1515 x 717 mm
3186722		1532 x 630 mm
3186721		1550 x 730 mm
3786147		1555 x 655 mm
3186960		1580 x 715 mm

Codice LF	Adattabile	Dimensioni
LF code	Suitable for	Dimensions
LF Nr.	Passend für	Maße
Cód. LF	Adaptable	Dimensiones

3186723		1619 x 740 mm
♦ 2101228		1627 x 518 mm
3186768		1645 x 710 mm
♦ 5028872		1686 x 537 mm
3186747		1695 x 570 mm
3786220		1695 x 570 mm
3786219		1699 x 562 mm
3186719		1713 x 558 mm
3186720		1722 x 550 mm

Cod. Profilo 1012

Profile no. 1012

Profil-Nr. 1012

Perfil nr. 1012

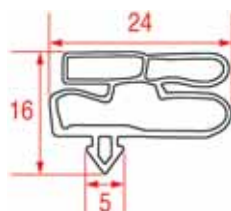

Non fornibile su misura

Special size not available

Sonderanfertigung nicht lieferbar

No disponible a medida

Codice LF	Adattabile	Dimensioni
LF code	Suitable for	Dimensions
LF Nr.	Passend für	Maße
Cód. LF	Adaptable	Dimensiones

3186863		660 x 500 mm
3186718		903 x 637 mm

Codice LF	Adattabile	Dimensioni
LF code	Suitable for	Dimensions
LF Nr.	Passend für	Maße
Cód. LF	Adaptable	Dimensiones

3186743		1695 x 745 mm
3786218		1700 x 740 mm



Cod. Profilo 1013

Profile no. 1013

Profil-Nr. 1013

Perfil nr. 1013

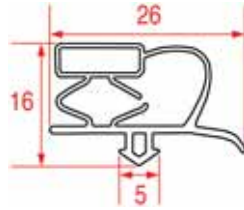

Non fornibile su misura

Special size not available

Sonderanfertigung nicht lieferbar

No disponible a medida

Codice LF LF code LF Nr. Cód. LF	Adattabile Suitable for Passend für Adaptable	Dimensioni Dimensions Maße Dimensiones
---	--	---

3186731		400 x 280 mm
3186620		475 x 175 mm
3186732		605 x 400 mm

Codice LF LF code LF Nr. Cód. LF	Adattabile Suitable for Passend für Adaptable	Dimensioni Dimensions Maße Dimensiones
---	--	---

3186733		740 x 640 mm
3186598		783 x 475 mm
3186734		1525 x 640 mm

Cod. Profilo 1014

Profile no. 1014

Profil-Nr. 1014

Perfil nr. 1014

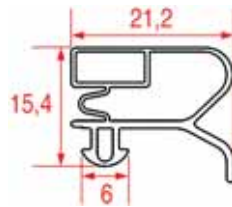

Per guarniz. su misura vedere Cod. Profilo 1006

For customized gaskets see Profile no. 1006

Für Dichtungen auf Maß siehe Profil-Nr. 1006

Para burletes a medida ver Perfil nr. 1006

Codice LF LF code LF Nr. Cód. LF	Adattabile Suitable for Passend für Adaptable	Dimensioni Dimensions Maße Dimensiones
---	--	---

3186865		398 x 306 mm
3186738		423 x 186 mm
3186737		423 x 295 mm
◆ 5008143		610 x 445 mm
3186736		620 x 423 mm
3186739		620 x 498 mm
3186839	(Tre lati - Three sides - Drei Seiten - Tres lados)	635 x 400 x 635 mm

Codice LF LF code LF Nr. Cód. LF	Adattabile Suitable for Passend für Adaptable	Dimensioni Dimensions Maße Dimensiones
---	--	---

3186936		741 x 651 mm
3186938		770 x 610 mm
3186914		1470 x 690 mm
3186782		1515 x 308 mm
3186781		1515 x 780 mm
3186846		1530 x 665 mm
3186937		1551 x 651 mm
3186939		1570 x 610 mm

Cod. Profilo 1015

Profile no. 1015

Profil-Nr. 1015

Perfil nr. 1015

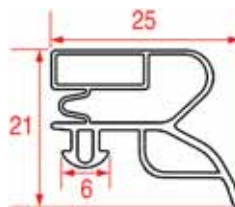

Per guarniz. su misura vedere Cod. Profilo 1006

For customized gaskets see Profile no. 1006

Für Dichtungen auf Maß siehe Profil-Nr. 1006

Para burletes a medida ver Perfil nr. 1006

Codice LF LF code LF Nr. Cód. LF	Adattabile Suitable for Passend für Adaptable	Dimensioni Dimensions Maße Dimensiones
---	--	---

3186866 ▲		1320 x 632 mm
-----------	--	---------------

▲ A esaurimento scorte verrà sostituito dal profilo 1006
When stock is finished, replaced by profile 1006
Wenn ausverkauft wird dieser Art. durch Profil 1006 ersetzt
Hasta agotar existencias, reemplazado por perfil 1006



Cod. Profilo 1016

Profile no. 1016

Profil-Nr. 1016

Perfil nr. 1016



A richiesta forniamo guarnizioni su misura

Upon request we supply customized gaskets

Auf Anfrage liefern wir Dichtungen auf Maß

A petición proporcionamos burletes a medida

<i>Codice LF</i>	<i>Adattabile</i>	<i>Dimensioni</i>
<i>LF code</i>	<i>Suitable for</i>	<i>Dimensions</i>
<i>LF Nr.</i>	<i>Passend für</i>	<i>Maße</i>
<i>Cód. LF</i>	<i>Adaptable</i>	<i>Dimensiones</i>

◆ 5024490		375 x 205 mm
3786240		390 x 200 mm
3786241		390 x 305 mm
◆ 5000095		393 x 372 mm
★	FRIULINOX - 925157	394 x 193 mm
◆ 5030745		395 x 265 mm
3186486		405 x 270 mm
3186509		405 x 280 mm
3786234		407 x 186 mm
3786233		407 x 296 mm
3186511		410 x 185 mm
3186976		410 x 390 mm
◆ 5027893		437 x 369 mm
★	FRIULINOX - 925316	463 x 163 mm
★	FRIULINOX - 925317	463 x 372 mm
◆ 5000088		464 x 283 mm
3286054		475 x 190 mm
3286055		475 x 295 mm
3286056		475 x 400 mm
3186583		485 x 290 mm
★	FRIULINOX - 925800	485 x 303 mm
◆ 5029069		530 x 375 mm
3186487		570 x 405 mm
★	FRIULINOX - 925068	580 x 184 mm
★	FRIULINOX - 925069	580 x 292 mm
◆ 5011490		580 x 400 mm
3186510		590 x 405 mm
★	FRIULINOX - 925438	598 x 163 mm
★	FRIULINOX - 925437	598 x 267 mm
★	FRIULINOX - 925439	598 x 372 mm
3286057		605 x 475 mm
3286058		605 x 555 mm
3786232		626 x 407 mm

<i>Codice LF</i>	<i>Adattabile</i>	<i>Dimensioni</i>
<i>LF code</i>	<i>Suitable for</i>	<i>Dimensions</i>
<i>LF Nr.</i>	<i>Passend für</i>	<i>Maße</i>
<i>Cód. LF</i>	<i>Adaptable</i>	<i>Dimensiones</i>

3786239		630 x 390 mm
◆ 5000087		630 x 480 mm
3786231		635 x 590 mm
3786230		640 x 430 mm
◆ 5020092		640 x 465 mm
◆ 5028865		647 x 485 mm
◆ 5026149		660 x 500 mm
★	FRIULINOX - 925434	668 x 163 mm
★	FRIULINOX - 925433	668 x 267 mm
★	FRIULINOX - 925435	668 x 372 mm
◆ 5000099		678 x 210 mm
◆ 5018958		680 x 590 mm
3186488		705 x 645 mm
◆ 5011498		707 x 441 mm
3786238		750 x 690 mm
3786235		770 x 670 mm
◆ 5030168		940 x 380 mm
3786229		1190 x 550 mm
★	FRIULINOX - 965040	1209 x 708 mm
◆ 5031633		1405 x 655 mm
◆ 5029835		1444 x 375 mm
◆ 5011502		1477 x 660 mm
3186919		1480 x 640 mm
◆ 4089735		1492 x 626 mm
★	FRIULINOX - 935560	1506 x 798 mm
3786237		1525 x 690 mm
◆ 5011472		1560 x 790 mm
◆ 5022908		1570 x 615 mm
3786236		1570 x 670 mm
◆ 5031774		1750 x 650 mm
◆ 5000101		1838 x 780 mm
◆ 5011467		1860 x 760 mm
◆ 5011504		1960 x 710 mm



Guarnizioni ad incastro • Snap-in gaskets Steckdichtungen • Burletes de encastre

Cod. Profilo 1017

Profile no. 1017

Profil-Nr. 1017

Perfil nr. 1017

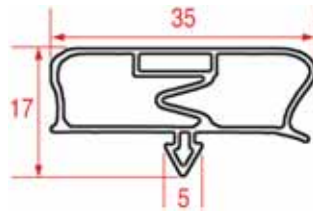

Non fornibile su misura

Special size not available

Sonderanfertigung nicht lieferbar

No disponible a medida

Codice LF LF code LF Nr. Cód. LF	Adattabile Suitable for Passend für Adaptable	Dimensioni Dimensions Maße Dimensiones
3186641		456 x 426 mm
3186647		530 x 495 mm
3186646		576 x 501 mm
3186645		603 x 455 mm
3186644		690 x 660 mm

Codice LF LF code LF Nr. Cód. LF	Adattabile Suitable for Passend für Adaptable	Dimensioni Dimensions Maße Dimensiones
3186640		776 x 426 mm
3186642		1396 x 631 mm
3186643		1396 x 740 mm
♦ 5027514		1542 x 631 mm

Cod. Profilo 1018

Profile no. 1018

Profil-Nr. 1018

Perfil nr. 1018

IME / Turbo

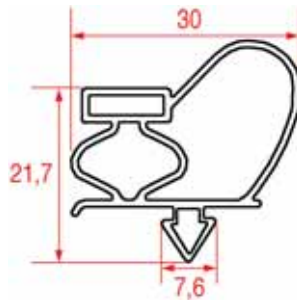

A richiesta forniamo guarnizioni su misura

Upon request we supply customized gaskets

Auf Anfrage liefern wir Dichtungen auf Maß

A petición proporcionamos burletes a medida

Codice LF LF code LF Nr. Cód. LF	Adattabile Suitable for Passend für Adaptable	Dimensioni Dimensions Maße Dimensiones
♦ 5030372		430 x 310 mm
♦ 5025841		633 x 434 mm
♦ 5029068		716 x 713 mm
3186670		720 x 450 mm
3186672		730 x 580 mm

Codice LF LF code LF Nr. Cód. LF	Adattabile Suitable for Passend für Adaptable	Dimensioni Dimensions Maße Dimensiones
♦ 5029866		795 x 510 mm
♦ 5032040		850 x 750 mm
3186671		1515 x 450 mm
3186673		1520 x 480 mm
♦ 5027695		1650 x 710 mm

Disponibile anche in barre per "fai da te", cod. **3186777** vedi pag. 37

Also available in lengths for "do-it-yourself", LF code no. **3186777** see page 39

Auch in Standardstücken für "Selbstbau" vorhanden, LF Art. Nr. **3186777** auf Seite 41

Disponibles también en tiras para "hazlo tú mismo" cód. **3186777** ver página 43

- ♦ Art. LF non gestito a magazzino - LF part no. not in stock - LF Art. Nr. nicht lagermäßig geführt - Art. LF no presente en almacén
- ★ A richiesta - Upon request - Auf Anfrage - A petición



Cod. Profilo 1019

Profile no. 1019

Profil-Nr. 1019

Perfil nr. 1019

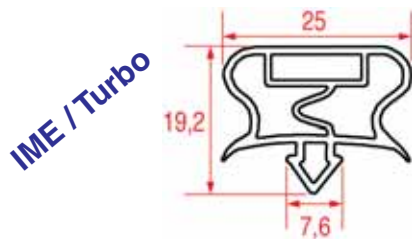

A richiesta forniamo guarnizioni su misura

Upon request we supply customized gaskets

Auf Anfrage liefern wir Dichtungen auf Maß

A petición proporcionamos burletes a medida

Codice LF LF code LF Nr. Cód. LF	Adattabile Suitable for Passend für Adaptable	Dimensioni Dimensions Maße Dimensiones
---	--	---

◆ 5032374		425 x 320 mm
◆ 5026470		430 x 230 mm
◆ 5026471		430 x 370 mm
◆ 5029775		445 x 315 mm
◆ 5030191		525 x 325 mm
◆ 5030192		525 x 445 mm
◆ 5026313		530 x 390 mm
◆ 5029774		595 x 390 mm
◆ 5032375		650 x 425 mm
◆ 5029776		660 x 445 mm
◆ 5028913		665 x 417 mm

Codice LF LF code LF Nr. Cód. LF	Adattabile Suitable for Passend für Adaptable	Dimensioni Dimensions Maße Dimensiones
---	--	---

◆ 5028898		710 x 410 mm
3186674		750 x 464 mm
3186676		750 x 494 mm
◆ 5026235		750 x 550 mm
◆ 5027256		920 x 890 mm
3186677		1350 x 440 mm
3186675		1350 x 464 mm
◆ 5029773		1560 x 660 mm
◆ 5029724	(Tre lati - Three sides - Drei Seiten - Tres lados)	1900 x 650 x 1900 mm
◆ 5030128		1990 x 855 mm

Disponibile anche in barre per "fai da te", cod. **3186778** vedi pag. 37

Also available in lengths for "do-it-yourself", LF code no. **3186778** see page 39

Auch in Standardstücken für "Selbstbau" vorhanden, LF Art. Nr. **3186778** auf Seite 41

Disponibles también en tiras para "hazlo tú mismo" cód. **3186778** ver página 43



Cod. Profilo 1020

Profile no. 1020

Profil-Nr. 1020

Perfil nr. 1020

Franke



A richiesta forniamo guarnizioni su misura

Upon request we supply customized gaskets

Auf Anfrage liefern wir Dichtungen auf Maß

A petición proporcionamos burletes a medida

Codice LF LF code LF Nr. Cód. LF	Adattabile Suitable for Passend für Adaptable	Dimensioni Dimensions Maße Dimensiones
---	--	---

◆ 5028951		375 x 265 mm
3186680		380 x 225 mm
◆ 5030784		380 x 290 mm
◆ 5030673		380 x 305 mm
◆ 5027049		380 x 345 mm
◆ 5030675		380 x 380 mm
3186679		386 x 200 mm
◆ 5030785		390 x 380 mm
◆ 5029522		392 x 232 mm
◆ 5030151		405 x 230 mm
◆ 5027050		415 x 380 mm
◆ 5031127		445 x 386 mm
◆ 5030049		480 x 350 mm
◆ 5030479		480 x 445 mm
◆ 5028554		560 x 420 mm
3186678		580 x 335 mm
◆ 5027048		585 x 415 mm
◆ 5029559		592 x 472 mm

Codice LF LF code LF Nr. Cód. LF	Adattabile Suitable for Passend für Adaptable	Dimensioni Dimensions Maße Dimensiones
---	--	---

◆ 5030674		595 x 385 mm
◆ 5027339		595 x 560 mm
◆ 5028952		600 x 400 mm
◆ 5030152		610 x 230 mm
◆ 5030126		642 x 382 mm
3186681		652 x 380 mm
◆ 5029074		700 x 385 mm
◆ 5030790		710 x 310 mm
◆ 5030269		770 x 525 mm
◆ 5029253		815 x 630 mm
◆ 5030048		820 x 480 mm
◆ 5025376		1550 x 630 mm
◆ 5026374		1565 x 665 mm
◆ 5025375		1685 x 630 mm
◆ 5030748		1744 x 754 mm
◆ 5026621		1753 x 760 mm
◆ 5026373		1800 x 635 mm

Disponibile anche in barre per "fai da te", cod. **3186779** vedi pag. 37

Also available in lengths for "do-it-yourself", LF code no. **3186779** see page 39

Auch in Standardstücken für "Selbstbau" vorhanden, LF Art. Nr. **3186779** auf Seite 41

Disponibles también en tiras para "hazlo tú mismo" cód. **3186779** ver página 43

Cod. Profilo 1021

Profile no. 1021

Profil-Nr. 1021

Perfil nr. 1021

IME / Turbo

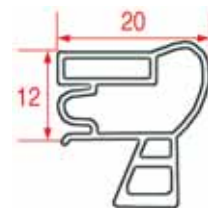

A richiesta forniamo guarnizioni su misura

Upon request we supply customized gaskets

Auf Anfrage liefern wir Dichtungen auf Maß

A petición proporcionamos burletes a medida

Codice LF LF code LF Nr. Cód. LF	Adattabile Suitable for Passend für Adaptable	Dimensioni Dimensions Maße Dimensiones
---	--	---

3186690		600 x 440 mm
---------	--	--------------

- ◆ Art. LF non gestito a magazzino - LF part no. not in stock - LF Art. Nr. nicht lagermäßig geführt - Art. LF no presente en almacén
- ★ A richiesta - Upon request - Auf Anfrage - A petición



Cod. Profilo 1022

Profile no. 1022

Profil-Nr. 1022

Perfil nr. 1022

IME / Turbo



A richiesta forniamo guarnizioni su misura

Upon request we supply customized gaskets

Auf Anfrage liefern wir Dichtungen auf Maß

A petición proporcionamos burletes a medida

Codice LF	Adattabile	Dimensioni
LF code	Suitable for	Dimensions
LF Nr.	Passend für	Maße
Cód. LF	Adaptable	Dimensiones

3186682		385 x 205 mm
3186683		385 x 320 mm
3186685		385 x 370 mm
3186686		410 x 202 mm
3186687		410 x 317 mm
3186684		435 x 385 mm

Codice LF	Adattabile	Dimensioni
LF code	Suitable for	Dimensions
LF Nr.	Passend für	Maße
Cód. LF	Adaptable	Dimensiones

3186688		437 x 410 mm
♦ 5030178		660 x 500 mm
3186689		665 x 410 mm
♦ 5030801		1125 x 715 mm
♦ 5029014		1180 x 627 mm
♦ 5027279		1570 x 570 mm

Cod. Profilo 1023

Profile no. 1023

Profil-Nr. 1023

Perfil nr. 1023

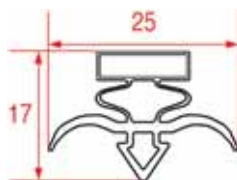

A richiesta forniamo guarnizioni su misura

Upon request we supply customized gaskets

Auf Anfrage liefern wir Dichtungen auf Maß

A petición proporcionamos burletes a medida

Codice LF	Adattabile	Dimensioni
LF code	Suitable for	Dimensions
LF Nr.	Passend für	Maße
Cód. LF	Adaptable	Dimensiones

♦ 5030132		390 x 290 mm
♦ 5032390		410 x 300 mm
♦ 5030854		510 x 385 mm
♦ 5030131		595 x 390 mm
♦ 5028953		595 x 405 mm
♦ 5027725		630 x 427 mm
♦ 5027721		630 x 480 mm
♦ 5032391		645 x 415 mm
♦ 5029777		665 x 625 mm

Codice LF	Adattabile	Dimensioni
LF code	Suitable for	Dimensions
LF Nr.	Passend für	Maße
Cód. LF	Adaptable	Dimensiones

♦ 5030153		680 x 580 mm
♦ 5028553		710 x 410 mm
♦ 5032003		840 x 485 mm
♦ 5027827		1130 x 745 mm
♦ 5029345		1320 x 615 mm
♦ 5027099		1550 x 600 mm
♦ 5031047		1640 x 735 mm
♦ 5031918		1880 x 810 mm

Disponibile anche in barre per "fai da te", cod. **3186870** vedi pag. 37

Also available in lengths for "do-it-yourself", LF code no. **3186870** see page 39

Auch in Standardstücken für "Selbstbau" vorhanden, LF Art. Nr. **3186870** auf Seite 41

Disponibles también en tiras para "hazlo tú mismo" cód. **3186870** ver página 43



Cod. Profilo 1024

Profile no. 1024

Profil-Nr. 1024

Perfil nr. 1024



Non fornibile su misura

Special size not available

Sonderanfertigung nicht lieferbar

No disponible a medida

Disponibile solo in barre per "fai da te", cod. **3186824** vedi pag. 37

Available in lengths for "do-it-yourself" only, LF code no. **3186824** see page 39

Nur in Standardstücken für "Selbstbau" vorhanden, LF Art. Nr. **3186824** auf Seite 41

Disponibles solamente en tiras para "hazlo tú mismo" cód. **3186824** ver página 43

Cod. Profilo 1025

Profile no. 1025

Profil-Nr. 1025

Perfil nr. 1025

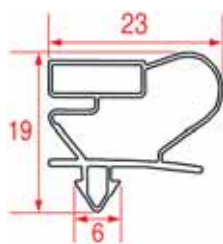

A richiesta forniamo guarnizioni su misura

Upon request we supply customized gaskets

Auf Anfrage liefern wir Dichtungen auf Maß

A petición proporcionamos burletes a medida

Codice LF	Adattabile	Dimensioni
LF code	Suitable for	Dimensions
LF Nr.	Passend für	Maße
Cód. LF	Adaptable	Dimensiones

3186623		385 x 260 mm
♦ 5016115		390 x 260 mm
♦ 5030970		425 x 295 mm
♦ 5032268		480 x 210 mm
♦ 5027949		480 x 350 mm
♦ 5026795		505 x 405 mm
♦ 5031498		530 x 383 mm
♦ 5022718		570 x 373 mm
♦ 5006670		590 x 385 mm
♦ 5026796		600 x 440 mm
♦ 5031845		610 x 460 mm
♦ 5008140		615 x 400 mm
♦ 5026797		625 x 485 mm

Codice LF	Adattabile	Dimensioni
LF code	Suitable for	Dimensions
LF Nr.	Passend für	Maße
Cód. LF	Adaptable	Dimensiones

♦ 5027700		628 x 390 mm
♦ 5028011		640 x 480 mm
♦ 5029331		640 x 495 mm
3186630		715 x 670 mm
♦ 5032041		755 x 690 mm
3786005		765 x 670 mm
♦ 5017459		1415 x 660 mm
3186624		1520 x 670 mm
3186625		1530 x 670 mm
♦ 5028012		1550 x 690 mm
♦ 5028485		1575 x 665 mm
♦ 5014998		1610 x 610 mm
3186700		1630 x 665 mm



Cod. Profilo 1026 *NON MAGNETICA*

Profile no. 1026 *NOT MAGNETIC*

Profil-Nr. 1026 *NICHT MAGNETISCH*

Perfil nr. 1026 *NO MAGNÉTICO*



Non fornibile su misura

Special size not available

Sonderanfertigung nicht lieferbar

No disponible a medida

Disponibile solo in barre per "fai da te", cod. **3186078** vedi pag. 37

Available in lengths for "do-it-yourself" only, LF code no. **3186078** see page 39

Nur in Standardstücken für "Selbstbau" vorhanden, LF Art. Nr. **3186078** auf Seite 41

Disponibles solamente en tiras para "hazlo tú mismo" cód. **3186078** ver página 43

Cod. Profilo 1027 *NON MAGNETICA*

Profile no. 1027 *NOT MAGNETIC*

Profil-Nr. 1027 *NICHT MAGNETISCH*

Perfil nr. 1027 *NO MAGNÉTICO*

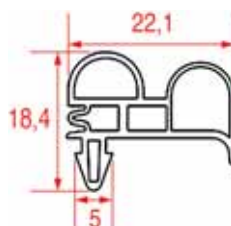

Non fornibile su misura

Special size not available

Sonderanfertigung nicht lieferbar

No disponible a medida

Disponibile solo in barre per "fai da te", cod. **3186880** vedi pag. 37

Available in lengths for "do-it-yourself" only, LF code no. **3186880** see page 39

Nur in Standardstücken für "Selbstbau" vorhanden, LF Art. Nr. **3186880** auf Seite 41

Disponibles solamente en tiras para "hazlo tú mismo" cód. **3186880** ver página 43

Cod. Profilo 1028 *NON MAGNETICA*

Profile no. 1028 *NOT MAGNETIC*

Profil-Nr. 1028 *NICHT MAGNETISCH*

Perfil nr. 1028 *NO MAGNÉTICO*

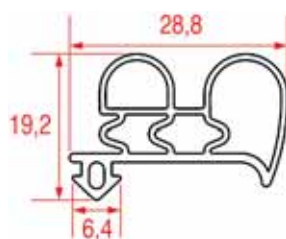

Non fornibile su misura

Special size not available

Sonderanfertigung nicht lieferbar

No disponible a medida

Codice LF	Adattabile	Dimensioni
LF code	Suitable for	Dimensions
LF Nr.	Passend für	Maße
Cód. LF	Adaptable	Dimensiones

◆ 5027980 1940 x 940 mm

Codice LF	Adattabile	Dimensioni
LF code	Suitable for	Dimensions
LF Nr.	Passend für	Maße
Cód. LF	Adaptable	Dimensiones

◆ 5027979 1940 x 1250 mm

Disponibile anche in barre per "fai da te", cod. **3186711** vedi pag. 37

Also available in lengths for "do-it-yourself" only, LF code no. **3186711** see page 39

Auch in Standardstücken für "Selbstbau" vorhanden, LF Art. Nr. **3186711** auf Seite 41

Disponibles también en tiras para "hazlo tú mismo" cód. **3186711** ver página 43



Guarnizioni ad incastro • Snap-in gaskets Steckdichtungen • Burletes de encastre

Cod. Profilo 1029
Profile no. 1029
Profil-Nr. 1029
Perfil nr. 1029

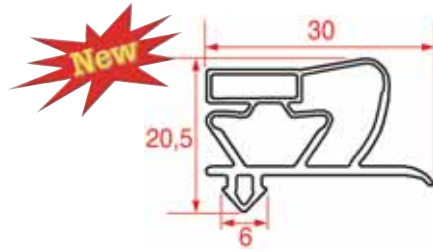

A richiesta forniamo guarnizioni su misura
Upon request we supply customized gaskets
Auf Anfrage liefern wir Dichtungen auf Maß
A petición proporcionamos burletes a medida

Codice LF LF code LF Nr. Cód. LF	Adattabile Suitable for Passend für Adaptable	Dimensioni Dimensions Maße Dimensiones
---	--	---

◆ 5030498 770 x 535 mm

Codice LF LF code LF Nr. Cód. LF	Adattabile Suitable for Passend für Adaptable	Dimensioni Dimensions Maße Dimensiones
---	--	---

◆ 5028861 (Tre lati - Three sides - Drei Seiten - Tres lados)
2245 x 1275 x 2245 mm

Cod. Profilo 1030
Profile no. 1030
Profil-Nr. 1030
Perfil nr. 1030



Non fornibile su misura
Special size not available
Sonderanfertigung nicht lieferbar
No disponible a medida

Codice LF LF code LF Nr. Cód. LF	Adattabile Suitable for Passend für Adaptable	Dimensioni Dimensions Maße Dimensiones
---	--	---

3786158 720 x 630 mm

Codice LF LF code LF Nr. Cód. LF	Adattabile Suitable for Passend für Adaptable	Dimensioni Dimensions Maße Dimensiones
---	--	---

3786159 1550 x 645 mm

Cod. Profilo 1031
Profile no. 1031
Profil-Nr. 1031
Perfil nr. 1031

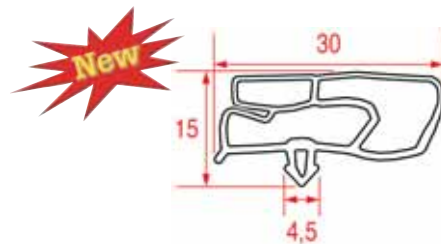

Non fornibile su misura
Special size not available
Sonderanfertigung nicht lieferbar
No disponible a medida

Codice LF LF code LF Nr. Cód. LF	Adattabile Suitable for Passend für Adaptable	Dimensioni Dimensions Maße Dimensiones
---	--	---

3186621 400 x 390 mm
3186659 580 x 385 mm
3186660 580 x 460 mm
3186662 690 x 635 mm
3186735 740 x 640 mm

Codice LF LF code LF Nr. Cód. LF	Adattabile Suitable for Passend für Adaptable	Dimensioni Dimensions Maße Dimensiones
---	--	---

3186661 775 x 460 mm
3186658 825 x 485 mm
3186663 1455 x 635 mm
3186664 1700 x 600 mm

◆ Art. LF non gestito a magazzino - LF part no. not in stock - LF Art. Nr. nicht lagermäßig geführt - Art. LF no presente en almacén
★ A richiesta - Upon request - Auf Anfrage - A petición



GUARNIZIONI PER ABBATTITORI
GASKETS FOR BLAST CHILLERS
DICHTUNGEN FÜR SCHOCKFROSTER
BURLETES PARA ABATIDORES

Cod. Profilo 1001
Profile no. 1001
Profil-Nr. 1001
Perfil nr. 1001

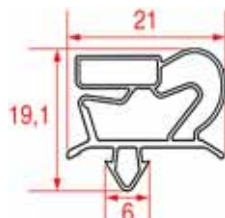

A richiesta forniamo guarnizioni su misura
Upon request we supply customized gaskets
Auf Anfrage liefern wir Dichtungen auf Maß
A petición proporcionamos burletes a medida

Codice LF LF code LF Nr. Cód. LF	Adattabile Suitable for Passend für Adaptable	Dimensioni Dimensions Maße Dimensiones
---	--	---

3186541		382 x 316 mm
♦ 5026642		470 x 365 mm
3186783		505 x 365 mm
3286053		605 x 370 mm
♦ 5024865		655 x 415 mm
3186595		660 x 420 mm
♦ 5025658		668 x 412 mm
3186648		675 x 405 mm
3186784		680 x 415 mm
3186558		685 x 425 mm
♦ 5025001		690 x 400 mm
3186627		690 x 440 mm
3186637		700 x 405 mm
3186566		710 x 450 mm
3186655		715 x 535 mm
3186584		720 x 435 mm
3186559		720 x 570 mm
♦ 5028529		725 x 400 mm
3186542		726 x 410 mm

Codice LF LF code LF Nr. Cód. LF	Adattabile Suitable for Passend für Adaptable	Dimensioni Dimensions Maße Dimensiones
---	--	---

★	ZANUSSI - 084124	736 x 703 mm
3186587		740 x 630 mm
3186649		795 x 715 mm
3186622		835 x 690 mm
3186785		835 x 720 mm
3186594		850 x 715 mm
3186560		850 x 725 mm
♦ 5028651		910 x 780 mm
3186766		925 x 745 mm
3186586		950 x 735 mm
3186596		1017 x 958 mm
3186543		1060 x 730 mm
♦ 5026693		1070 x 770 mm
3186764		1080 x 715 mm
3186585		1185 x 735 mm
3186567		1225 x 710 mm
3186607		1520 x 715 mm
♦ 5027149		1880 x 910 mm
★	IRINOX - 1010800	2044 x 1181 mm

Cod. Profilo 1005
Profile no. 1005
Profil-Nr. 1005
Perfil nr. 1005

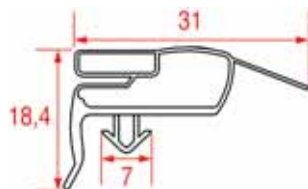

Non fornibile su misura
Special size not available
Sonderanfertigung nicht lieferbar
No disponible a medida

Codice LF LF code LF Nr. Cód. LF	Adattabile Suitable for Passend für Adaptable	Dimensioni Dimensions Maße Dimensiones
---	--	---

3186473		660 x 385 mm
---------	--	--------------



GUARNIZIONI PER ABBATTITORI
GASKETS FOR BLAST CHILLERS
DICHTUNGEN FÜR SCHOCKFROSTER
BURLETES PARA ABATIDORES

Cod. Profilo 1006
Profile no. 1006
Profil-Nr. 1006
Perfil nr. 1006

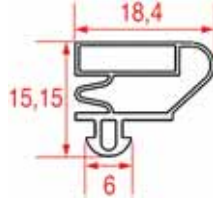

A richiesta forniamo guarnizioni su misura
Upon request we supply customized gaskets
Auf Anfrage liefern wir Dichtungen auf Maß
A petición proporcionamos burletes a medida

Codice LF LF code LF Nr. Cód. LF	Adattabile Suitable for Passend für Adaptable	Dimensioni Dimensions Maße Dimensiones
◆ 5025778		385 x 315 mm
3186551		710 x 378 mm
3186550		710 x 437 mm

Codice LF LF code LF Nr. Cód. LF	Adattabile Suitable for Passend für Adaptable	Dimensioni Dimensions Maße Dimensiones
3186552		862 x 716 mm
3186553		1172 x 716 mm

Cod. Profilo 1016
Profile no. 1016
Profil-Nr. 1016
Perfil nr. 1016

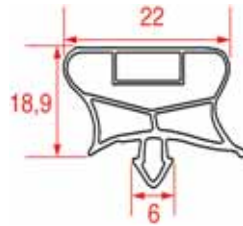

A richiesta forniamo guarnizioni su misura
Upon request we supply customized gaskets
Auf Anfrage liefern wir Dichtungen auf Maß
A petición proporcionamos burletes a medida

Codice LF LF code LF Nr. Cód. LF	Adattabile Suitable for Passend für Adaptable	Dimensioni Dimensions Maße Dimensiones
3186568		598 x 480 mm
3186710		682 x 423 mm
◆ 5029870		690 x 425 mm
◆ 5030936		710 x 420 mm
◆ 5004507		713 x 360 mm
3186489		755 x 690 mm

Codice LF LF code LF Nr. Cód. LF	Adattabile Suitable for Passend für Adaptable	Dimensioni Dimensions Maße Dimensiones
◆ 5000080		824 x 708 mm
3186638		840 x 705 mm
3186565		843 x 712 mm
3186639		1120 x 700 mm
3186607		1520 x 715 mm

GUARNIZIONI MEZZOBORDO • MIDDLE-EDGED GASKETS DICHTUNGEN MIT HALBRAHMEN • BURLETES DE MEDIO BORDE

ATTENZIONE

Le guarnizioni sono elencate in ordine crescente di misura, prima il lato maggiore poi il minore.
Tutte le misure indicate sono esterne.

ATTENTION

Gaskets are listed by size in increasing order, first the larger then the smaller side.
All indicated sizes are external.

ACHTUNG

Die Dichtungen sind mit steigendem Maß aufgelistet, zuerst die größere und dann die kleinere Seite.
Es handelt sich immer um das Außenmaß.

ATENCIÓN

Los burletes se enumeran en la orden de aumento de la medida, primero el lado mayor
después el lado menor. Todas las medidas indicadas son externas.

COME MISURARE LE GUARNIZIONI • HOW TO MEASURE GASKETS DICHTUNGEN ABMEßEN • COMO MEDIR LOS BURLETES

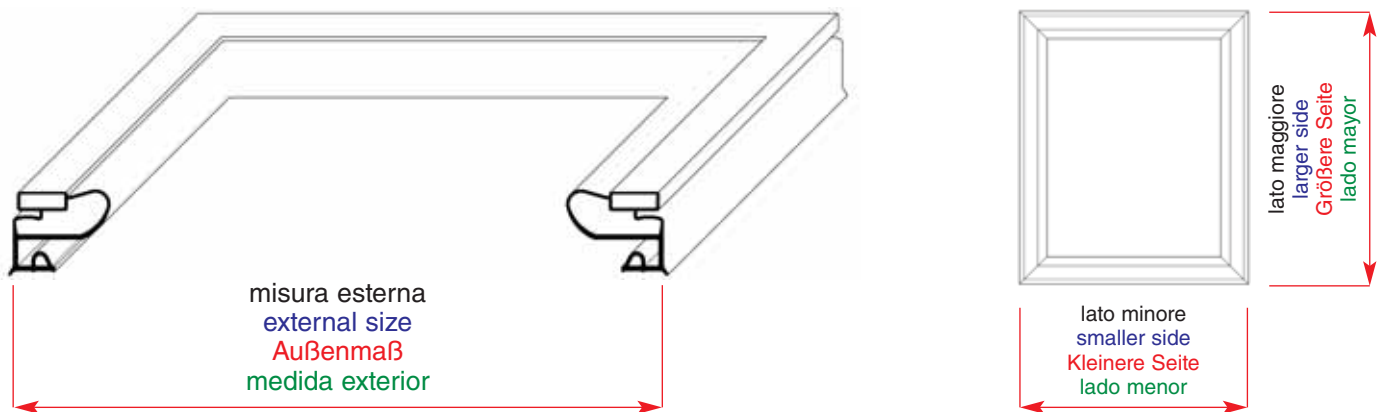

A richiesta forniamo guarnizioni su misura.
Comunicateci il codice del profilo e la misura esterna in mm dei lati.
Attenzione: non si accettano resi di guarnizioni realizzate su misura.

Upon request we supply customized gaskets.
Please, indicate the profile code and the external dimensions of each side expressed in mm.
Attention: customized gaskets cannot be returned.

Auf Anfrage liefern wir Dichtungen auf Maß.
Bitte geben Sie das Dichtungsprofil und das Außenmaß der Seiten in mm an.
Achtung: Rücksendung von angefertigten Dichtungen wird nicht akzeptiert.

A petición proporcionamos burletes a medida.
Comunique el código del perfil y la medida exterior en mm de los lados.
Atención: no aceptamos devoluciones de burletes realizados a medida.



Guarnizioni mezzobordo • Middle-edged gaskets Dichtungen mit Halbrahmen • Burletes de medio borde

Cod. Profilo 2001

Profile no. 2001

Profil-Nr. 2001

Perfil nr. 2001

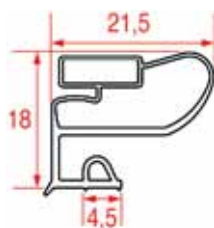

A richiesta forniamo guarnizioni su misura

Upon request we supply customized gaskets

Auf Anfrage liefern wir Dichtungen auf Maß

A petición proporcionamos burletes a medida

Codice LF LF code LF Nr. Cód. LF	Adattabile Suitable for Passend für Adaptable	Dimensioni Dimensions Maße Dimensiones
---	--	---

♦ 5026265		382 x 215 mm
3186926		382 x 335 mm
3186080		390 x 185 mm
3186769		390 x 198 mm
3186086		390 x 206 mm
3186770		390 x 306 mm
3186081		390 x 310 mm
★	ZANUSSI - 0A8379	391 x 200 mm
★	ZANUSSI - 0A8389	391 x 226 mm
★	ZANUSSI - 0A8385	391 x 234 mm
★	ZANUSSI - 0A8106	391 x 302 mm
★	ZANUSSI - 0A8388	391 x 353 mm
★	ZANUSSI - 0A8381	391 x 361 mm
★	DEXION - 015574-00	394 x 380 mm
★	ZANUSSI - 0A8383	403 x 391 mm
3786057		414 x 390 mm
3186969		422 x 255 mm
♦ 5029010		424 x 172 mm
3186570		424 x 182 mm
3786002		424 x 198 mm
★	DEXION - 017117-00	424 x 212 mm
★	DEXION - 017118-00	424 x 233 mm
★	DEXION - 017904-00	424 x 292 mm
3186571		424 x 302 mm
★	DEXION - 017116-00	424 x 352 mm
♦ 5009856		424 x 422 mm
♦ 5025861		430 x 402 mm
3186082		435 x 390 mm
♦ 5025659		465 x 320 mm
★	DEXION - 017114-00	471 x 424 mm
★	ZANUSSI - 0A8380	488 x 391 mm
★	ART SERF - 2320320	500 x 245 mm
★	ART SERF - 2320330	500 x 375 mm
♦ 5031793		505 x 235 mm
♦ 5031794		505 x 330 mm
♦ 5031497		510 x 490 mm
♦ 40A8318		530 x 485 mm
3186967		538 x 422 mm
♦ 40A8144		540 x 445 mm
♦ 5030224		570 x 385 mm
♦ 5030225		585 x 440 mm
3186925		590 x 382 mm
♦ 40A8386		591 x 310 mm

Codice LF LF code LF Nr. Cód. LF	Adattabile Suitable for Passend für Adaptable	Dimensioni Dimensions Maße Dimensiones
---	--	---

3786058		595 x 198 mm
3786059		595 x 306 mm
3786060		595 x 414 mm
★	DEXION - 016343-00	597 x 184 mm
★	DEXION - 016342-00	597 x 206 mm
★	DEXION - 014053-00	597 x 308 mm
♦ 5028394		620 x 424 mm
3186727		630 x 424 mm
3186573		630 x 630 mm
★	DEXION - 017109-00	631 x 182 mm
★	DEXION - 017110-00	631 x 198 mm
♦ 5023976		631 x 302 mm
3786055		634 x 390 mm
3786054		634 x 465 mm
3786056		634 x 595 mm
3186572		635 x 495 mm
3186840		635 x 598 mm
♦ 5009837		638 x 467 mm
3186083		640 x 390 mm
♦ 2111388		660 x 495 mm
♦ 40A8159		670 x 538 mm
3186968		678 x 538 mm
♦ 5027594		680 x 424 mm
♦ 5028899		700 x 380 mm
★	ZANUSSI - 0A8384	716 x 234 mm
★	DEXION - 017115-00	730 x 424 mm
★	ZANUSSI - 0A8394	742 x 391 mm
★	ZANUSSI - 0A8393	742 x 716 mm
★	FRIULINOX - 935046	762 x 672 mm
3186070		770 x 670 mm
♦ 5031795		775 x 505 mm
★	DEXION - 017815-00	815 x 184 mm
★	ART SERF - 2320310	815 x 500 mm
♦ 5028520		850 x 480 mm
★	ZANUSSI - 0A8340	873 x 792 mm
♦ 40A8378		1095 x 700 mm
★	ZANUSSI - 0A8387	1122 x 420 mm
♦ 40A8369		1540 x 660 mm
♦ 5009855		1554 x 688 mm
♦ 5000086		1562 x 672 mm
3186075		1570 x 670 mm
♦ 5030228		1570 x 785 mm
♦ 40A8410		1778 x 774 mm

Disponibile anche in barre per "fai da te", cod. **3186848** e **3186871** vedi pag. 37

Also available in lengths for "do-it-yourself", LF code no. **3186848** and **3186871** see page 39

Auch in Standardstücken für "Selbstbau" vorhanden, LF Art. Nr. **3186848** und **3186871** auf Seite 41

Disponibles también en tiras para "hazlo tú mismo" cód. **3186848** y **3186871** ver página 43



Cod. Profilo 2002

Profile no. 2002

Profil-Nr. 2002

Perfil nr. 2002

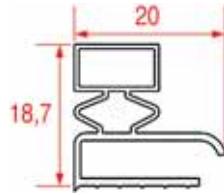

A richiesta forniamo guarnizioni su misura

Upon request we supply customized gaskets

Auf Anfrage liefern wir Dichtungen auf Maß

A petición proporcionamos burletes a medida

<i>Codice LF</i>	<i>Adattabile</i>	<i>Dimensioni</i>
<i>LF code</i>	<i>Suitable for</i>	<i>Dimensions</i>
<i>LF Nr.</i>	<i>Passend für</i>	<i>Maße</i>
<i>Cód. LF</i>	<i>Adaptable</i>	<i>Dimensiones</i>

♦ 5032352		380 x 280 mm
♦ 5030782		380 x 298 mm
3186956		385 x 190 mm
♦ 5030053		385 x 220 mm
♦ 5030054		385 x 245 mm
♦ 5030055		385 x 325 mm
3186853		388 x 308 mm
♦ 5026813		395 x 300 mm
♦ 5027403		410 x 260 mm
♦ 5028954		430 x 200 mm
♦ 5025497		455 x 395 mm
♦ 5029513		495 x 330 mm
♦ 5029514		495 x 405 mm
♦ 5030287		520 x 320 mm
♦ 5028303		525 x 425 mm
♦ 2100900		530 x 385 mm
♦ 5026364		540 x 420 mm
♦ 5027478		540 x 445 mm
♦ 5029127		555 x 420 mm
♦ 5026812		567 x 395 mm
♦ 5026737		570 x 165 mm
♦ 5027114		570 x 415 mm
♦ 5028459		575 x 375 mm
♦ 5025710		595 x 385 mm
♦ 5030597		600 x 440 mm
♦ 5027388		600 x 520 mm
3186962		605 x 455 mm
♦ 5030950		610 x 385 mm
3186841		610 x 580 mm
3186952		614 x 590 mm
3186889		636 x 388 mm

<i>Codice LF</i>	<i>Adattabile</i>	<i>Dimensioni</i>
<i>LF code</i>	<i>Suitable for</i>	<i>Dimensions</i>
<i>LF Nr.</i>	<i>Passend für</i>	<i>Maße</i>
<i>Cód. LF</i>	<i>Adaptable</i>	<i>Dimensiones</i>

♦ 5032277		640 x 455 mm
♦ 5027592		650 x 370 mm
3186837		660 x 500 mm
3186888		670 x 610 mm
♦ 5026963		680 x 440 mm
♦ 5026952		680 x 480 mm
♦ 5032376		690 x 495 mm
♦ 5025709		700 x 650 mm
♦ 5030013		705 x 396 mm
♦ 5030051		710 x 360 mm
♦ 5030052		710 x 440 mm
♦ 5028641		740 x 670 mm
♦ 5030289		750 x 520 mm
♦ 5029512		755 x 495 mm
♦ 5028837		770 x 705 mm
♦ 5028080		905 x 895 mm
♦ 5032267		920 x 120 mm
3186949		1360 x 660 mm
3186887		1400 x 610 mm
♦ 5027293		1430 x 605 mm
♦ 5030598		1435 x 775 mm
♦ 5028460		1458 x 584 mm
♦ 5028258		1480 x 645 mm
♦ 5028575		1485 x 705 mm
3186886		1530 x 620 mm
♦ 5031095		1530 x 635 mm
♦ 5028642		1550 x 670 mm
♦ 5027639		1585 x 605 mm
♦ 5030668		1590 x 675 mm
♦ 5030306		1645 x 705 mm
♦ 5028234		1840 x 830 mm

Disponibile anche in barre per "fai da te", cod. **3186849** e **3186872** vedi pag. 37

Also available in lengths for "do-it-yourself", LF code no. **3186849** and **3186872** see page 39

Auch in Standardstücken für "Selbstbau" vorhanden, LF Art. Nr. **3186849** und **3186872** auf Seite 41

Disponibles también en tiras para "hazlo tú mismo" cód. **3186849** y **3186872** ver página 43

- ♦ Art. LF non gestito a magazzino - LF part no. not in stock - LF Art. Nr. nicht lagermäßig geführt - Art. LF no presente en almacén
- ★ A richiesta - Upon request - Auf Anfrage - A petición



Guarnizioni mezzobordo • Middle-edged gaskets Dichtungen mit Halbrahmen • Burletes de medio borde

Cod. Profilo 2003

Profile no. 2003

Profil-Nr. 2003

Perfil nr. 2003

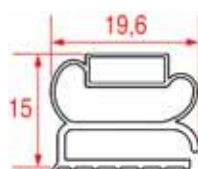

Per guarniz. su misura vedere Cod. Profilo 2004

For customized gaskets see Profile no. 2004

Für Dichtungen auf Maß siehe Profil-Nr. 2004

Para burletes a medida ver Perfil nr. 2004

Codice LF LF code LF Nr. Cód. LF	Adattabile Suitable for Passend für Adaptable	Dimensioni Dimensions Maße Dimensiones
---	--	---

3186951		755 x 660 mm
---------	--	--------------

Codice LF LF code LF Nr. Cód. LF	Adattabile Suitable for Passend für Adaptable	Dimensioni Dimensions Maße Dimensiones
---	--	---

3186950		1560 x 660 mm
---------	--	---------------

Cod. Profilo 2004

Profile no. 2004

Profil-Nr. 2004

Perfil nr. 2004

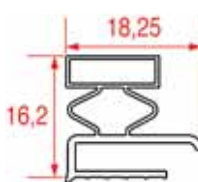

A richiesta forniamo guarnizioni su misura

Upon request we supply customized gaskets

Auf Anfrage liefern wir Dichtungen auf Maß

A petición proporcionamos burletes a medida

Codice LF LF code LF Nr. Cód. LF	Adattabile Suitable for Passend für Adaptable	Dimensioni Dimensions Maße Dimensiones
---	--	---

♦ 5025139		295 x 176 mm
♦ 5028912		330 x 225 mm
♦ 5028741		370 x 210 mm
♦ 5028381		375 x 175 mm
♦ 5028380		375 x 270 mm
♦ 5031576		380 x 160 mm
♦ 5029011		380 x 205 mm
♦ 5028570		380 x 285 mm
♦ 5031895		380 x 295 mm
♦ 5029822		385 x 245 mm
3186948		385 x 305 mm
♦ 5028998		390 x 190 mm
♦ 5028999		390 x 220 mm
♦ 5025875		395 x 270 mm
♦ 5030787		400 x 205 mm
♦ 5031574		410 x 235 mm
♦ 5028911		410 x 270 mm
♦ 5029826		420 x 320 mm
♦ 5029828		420 x 330 mm
3186771		425 x 285 mm
♦ 5027516		465 x 355 mm
♦ 5025379		466 x 396 mm
♦ 5025873		485 x 190 mm
♦ 5026930		485 x 385 mm
♦ 5025874		485 x 395 mm
♦ 5027808		490 x 385 mm
♦ 5027475		495 x 345 mm
♦ 5027474		495 x 405 mm
♦ 5027473		495 x 470 mm
♦ 5029819		500 x 405 mm
♦ 5028180		500 x 420 mm
♦ 5031195		503 x 385 mm
♦ 5025378		506 x 485 mm

Codice LF LF code LF Nr. Cód. LF	Adattabile Suitable for Passend für Adaptable	Dimensioni Dimensions Maße Dimensiones
---	--	---

♦ 5028430		510 x 260 mm
♦ 5028429		510 x 325 mm
♦ 5028427		510 x 410 mm
♦ 5028428		510 x 465 mm
♦ 5028425		515 x 215 mm
♦ 5026314		515 x 395 mm
♦ 5026890		520 x 320 mm
♦ 5030694		525 x 245 mm
♦ 5031897		525 x 365 mm
♦ 5030681		525 x 425 mm
♦ 5031898		525 x 455 mm
♦ 5028678		530 x 380 mm
♦ 5027951		540 x 445 mm
♦ 5030308		545 x 335 mm
♦ 5030307		545 x 425 mm
♦ 5029820		550 x 385 mm
♦ 5025979		565 x 410 mm
♦ 5030630		575 x 370 mm
♦ 5029511		580 x 400 mm
3186823		595 x 325 mm
3186772		600 x 425 mm
♦ 5028659		600 x 450 mm
♦ 5031171		600 x 600 mm
3186947		605 x 375 mm
♦ 5030154		605 x 485 mm
♦ 5030774		605 x 500 mm
♦ 5031573		610 x 475 mm
♦ 5029000		615 x 410 mm
♦ 5029070		615 x 425 mm
♦ 5029569		620 x 350 mm
♦ 5030061		625 x 600 mm





Cod. Profilo 2004

Profile no. 2004

Profil-Nr. 2004

Perfil nr. 2004

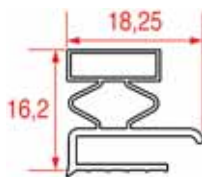

A richiesta forniamo guarnizioni su misura

Upon request we supply customized gaskets

Auf Anfrage liefern wir Dichtungen auf Maß

A petición proporcionamos burletes a medida

Codice LF LF code LF Nr. Cód. LF	Adattabile Suitable for Passend für Adaptable	Dimensioni Dimensions Maße Dimensiones
---	--	---

♦ 5031575		630 x 370 mm
♦ 5025871		630 x 485 mm
♦ 5029821		630 x 570 mm
♦ 5029981		640 x 390 mm
♦ 5030786		640 x 435 mm
♦ 5026312		645 x 300 mm
♦ 5029001		645 x 375 mm
♦ 5030789		650 x 405 mm
♦ 5027926		650 x 596 mm
♦ 5029827		660 x 420 mm
♦ 5030237		708 x 643 mm
♦ 5031732		710 x 480 mm
♦ 5025872		730 x 270 mm
♦ 5030788		730 x 640 mm
♦ 5025377		735 x 276 mm
♦ 5031645		736 x 564 mm
♦ 5029825		740 x 200 mm
♦ 5027807		745 x 385 mm
♦ 5027950		745 x 570 mm
♦ 5028346		760 x 570 mm
♦ 5031475		760 x 660 mm
♦ 5028426		765 x 550 mm
♦ 5028431		770 x 490 mm
♦ 5032057		775 x 675 mm
♦ 5028179		780 x 500 mm
♦ 5030155		790 x 530 mm
♦ 5028424		800 x 535 mm
♦ 5028305		815 x 315 mm

Codice LF LF code LF Nr. Cód. LF	Adattabile Suitable for Passend für Adaptable	Dimensioni Dimensions Maße Dimensiones
---	--	---

♦ 5028923		830 x 600 mm
♦ 5029824		830 x 790 mm
♦ 5031896		845 x 395 mm
♦ 5031111		850 x 530 mm
♦ 5031128		900 x 625 mm
♦ 5032383		915 x 860 mm
♦ 5025324		925 x 925 mm
♦ 5031541		980 x 900 mm
♦ 5026835		985 x 985 mm
♦ 5027954		1420 x 590 mm
♦ 5029002		1420 x 755 mm
♦ 5028386		1470 x 585 mm
♦ 5028300		1485 x 700 mm
♦ 5029003		1505 x 505 mm
♦ 5029004		1505 x 755 mm
♦ 5029837		1540 x 735 mm
3186818		1552 x 322 mm
3186817		1552 x 805 mm
♦ 5031476		1560 x 660 mm
♦ 5032005		1565 x 670 mm
♦ 5032056		1585 x 675 mm
♦ 5030286		1590 x 620 mm
♦ 5029823		1670 x 790 mm
♦ 5028422		1810 x 910 mm
♦ 5028423		1810 x 975 mm
♦ 5027636		1845 x 836 mm
♦ 5030877		1905 x 942 mm
♦ 5030437		1925 x 790 mm

Disponibile anche in barre per "fai da te", cod. **3186875** vedi pag. 37

Also available in lengths for "do-it-yourself", LF code no. **3186875** see page 39

Auch in Standardstücken für "Selbstbau" vorhanden, LF Art. Nr. **3186875** auf Seite 41

Disponibles también en tiras para "hazlo tú mismo" cód. **3186875** ver página 43

Cod. Profilo 2005

Profile no. 2005

Profil-Nr. 2005

Perfil nr. 2005

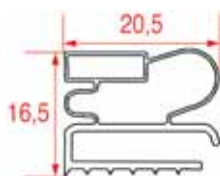

Non fornibile su misura

Special size not available

Sonderanfertigung nicht lieferbar

No disponible a medida

Disponibile solo in barre per "fai da te", cod. **3186867** vedi pag. 37

Available in lengths for "do-it-yourself" only, LF code no. **3186867** see page 39

Nur in Standardstücken für "Selbstbau" vorhanden, LF Art. Nr. **3186867** auf Seite 41

Disponibles solamente en tiras para "hazlo tú mismo" cód. **3186867** ver página 43

www.lfricambi724.mobi

1° Mobile shop del settore in Europa

Ora operativo in connessione Mobile, 7 giorni... 24 ore

Le nuove tecnologie possono sicuramente aiutare a risparmiare tempo e denaro...

...e  è sempre un passo avanti!



www.lfspareparts724.mobi

1st Mobile shop in the commercial catering market in Europe

Now fully working via mobile connection, 7 days... 24 hours

New technologies can certainly help to save time and money...

...and  is always a step ahead!



www.lfersatzteile724.mobi

www.lfersatzteilech724.mobi

1. Mobile Shop der Branche in Europa

Jetzt auch mobil, 7 Tage... 24 Stunden online

Die neuen Technologien können selbstverständlich dabei helfen, Zeit und Geld zu sparen...

...und  ist immer an der Spitze!



www.lfrepuestos724.mobi

1er. Móvil shop del sector en Europa

Ahora operativo en conexión móvil, 7 días... 24 horas

Las nuevas tecnologías pueden seguramente ayudar a ahorrar tiempo y dinero...

...¡y  está siempre un paso por delante!



GUARNIZIONI SU MISURA

Se non avete trovato la misura che vi serve tra quelle disponibili in elenco, potete richiederci di realizzarla su misura con un minimo d'ordine di 2 pezzi. Compilate l'apposito modulo d'ordine che trovate qui a lato ed inviatelo via fax, oppure ordinatele direttamente sul nostro sito www.lfcatering.com (password a richiesta).

Comunicateci il codice del profilo e la misura esterna in mm dei lati.

Attenzione: non si accettano resi di guarnizioni realizzate su misura.

CUSTOMIZED GASKETS

If you cannot find the size you need among the listed items, you can ask us for custom made gaskets, the minimum quantity is 2 pieces.

You can fill the special form you find here on the side and fax it to us, or you can place your order through our website: www.lfcatering.com (password upon request).

Please, indicate the profile code and the external dimensions of each side expressed in mm.

Attention: customized gaskets cannot be returned.

DICHTUNGEN AUF MAß

Wenn Sie die Dichtung, die Sie benötigen, nicht gefunden haben, dann können Sie sich auch eine nach Maß anfertigen lassen (mindestens 2 Dichtungen).

Füllen Sie das Bestellformular aus, das Sie auf der rechten Seite finden und schicken Sie es uns per Fax oder bestellen Sie die Dichtungen über unsere Webseiten www.lfcatering.de / [.ch](http://www.lfcatering.ch) (Passwort auf Anfrage).

Bitte geben Sie das Dichtungsprofil und das Außenmaß der Seiten in mm an.

Achtung: Rücksendung von angefertigten Dichtungen wird nicht akzeptiert.

BURLETES A MEDIDA

Si no ha encontrado la medida que le sirve entre las disponibles en el listado, puede pedir realizarlo a medida con un pedido mínimo de 2 unidades.

Puede rellenar el impreso correspondiente de pedido que encontrará aquí al lado y enviarlo via fax, o puede pedirlo directamente en nuestro sitio www.lfcatering.es (contraseña previa petición).

Rogamos nos comuniquen el código del perfil y la medida exterior en mm de los lados.

Atención: no se aceptan devoluciones de los burletes realizados a medida.

COME MISURARE LE GUARNIZIONI • HOW TO MEASURE GASKETS

DICHTUNGEN ABMEßEN • COMO MEDIR LOS BURLETES

Guarnizioni ad incastro
Snap-in gaskets
Steckdichtungen
Burletes de encastre

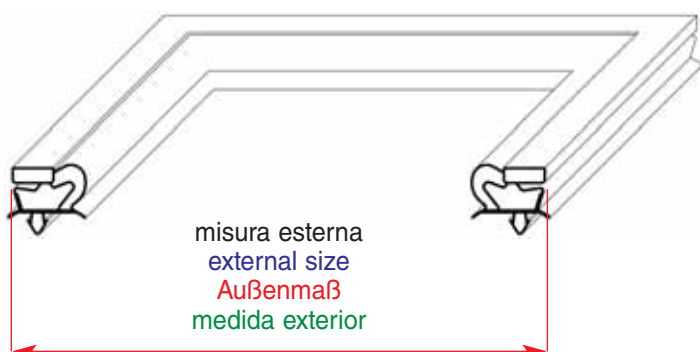

Guarnizioni mezzobordo
Middle-edged gaskets
Dichtungen mit Halbrahmen
Burletes de medio borde

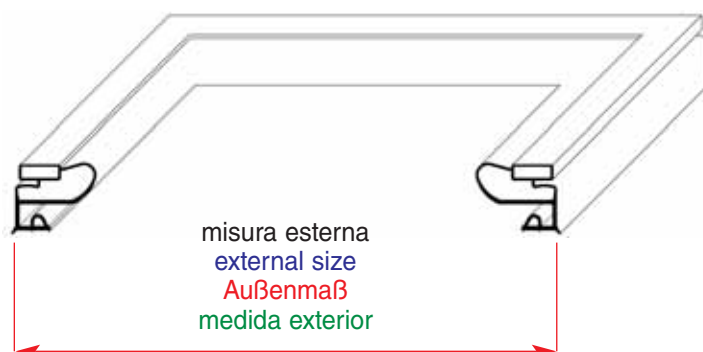



Modulo d'ordine per guarnizioni su misura
Order form for customized gaskets
Bestellformular für Dichtungen auf Maß
Modulo de pedido para burletes a medida

RICHIESTA PREVENTIVO - REQUEST FOR QUOTATION - ANGEBOTSANFRAGE - SOLICITUD DE PRECIO

ORDINE - ORDER - BESTELLUNG - PEDIDO

Fotocopiare, compilare e inviare via fax a:

- LF SpA - ITALIA 0547 34 11 10
- Export Dept. +39 0547 34 11 55
- LF GmbH - DEUTSCHLAND. . . . +49 89 89457888
- LF GmbH - SCHWEIZ +41 41 760 1585
- LF Oficina de venta - ESPAÑA . . +34 925 75 82 09
- 000 LF - RUSSIA +7 499 259 8575

Photocopy, fill-in and send by fax to:

Dieses Blatt ausfüllen und durchfaxen:

Rellenar el formulario y enviarlo por fax:

Quantità (min. 2 pz.) Qty (min. 2 pcs.) Menge (min. 2 Stk.) Cantidad (min. 2/u.)	Codice Profilo Profile code Profil-Nr. Perfil	Misura lunga (mm) Larger side (mm) Größere Seite (mm) Medida larga (mm)	Misura corta (mm) Smaller side (mm) Kleinere Seite (mm) Medida corta (mm)	Misura totale (mm) Total size (mm) Gesamtlänge (mm) Medida total (mm)	Prezzo unitario Unit price Einzelpreis Precio unitario	Prezzo totale Total price Gesamtpreis Precio total
---	--	--	--	--	---	---

1	Informazioni macchina: Information of the machine: Daten über das Gerät: Informaciones máquina:	(*) Marca Brand Hersteller Fabricante _____	(*) Modello Model Modell Modelo _____	(*) Tipologia Type Typ Tipo _____
---	--	--	--	--

2	Informazioni macchina: Information of the machine: Daten über das Gerät: Informaciones máquina:	(*) Marca Brand Hersteller Fabricante _____	(*) Modello Model Modell Modelo _____	(*) Tipologia Type Typ Tipo _____
---	--	--	--	--

3	Informazioni macchina: Information of the machine: Daten über das Gerät: Informaciones máquina:	(*) Marca Brand Hersteller Fabricante _____	(*) Modello Model Modell Modelo _____	(*) Tipologia Type Typ Tipo _____
---	--	--	--	--

L'ORDINE MINIMO PER LE GUARNIZIONI SU MISURA E' DI 2 PEZZI
MINIMUM ORDER AMOUNT FOR CUSTOMIZED GASKETS: 2 PIECES
MINDESTMENGE PRO ANGEFERTIGTE DICHTUNG: 2 STK.
EL PEDIDO MÍNIMO PARA BURLETES A MEDIDA ES 2 UNIDADES

* Se possibile, compilare
 * Pls, fill-in, if possible
 * Wenn möglich, bitte, hinzufügen
 * Si es posible, rellenar

NON SI EFFETTUANO SOSTITUZIONI PER LE GUARNIZIONI SU MISURA
CUSTOMIZED GASKETS CAN NEITHER BE REPLACED NOR RETURNED
RÜCKSENDUNG VON ANGEFERTIGTEN DICHTUNGEN WIRD NICHT AKZEPTIERT
NO SE CAMBIAN LOS BURLETES REALIZADOS A MEDIDA

Ditta / Company / Firma / Sociedad _____

P. IVA / VAT No. / Ust Nr. / ID Nr. / CIF-NIF _____ Codice cliente / Client no. / Kunden-Nr. / Cód. cliente _____

Via / Address / Adresse / Dirección _____ Città / City / Ort / Ciudad _____ Prov. / Country / Staat / País _____

Sig./Sig.ra / Mr/Mrs / Herr/Fr. / Sr./Sra. _____ Tel. _____ Fax _____

N° pagine / No. of pages / Seitenanzahl / Nr. páginas: _____ Data / Date / Datum / Fecha: _____ Firma / Signature / Unterschrift / Firma: _____

Problemi di guarnizioni speciali?

La miglior soluzione è il "fai da te"!

Nonostante l'ampia gamma di guarnizioni nei nostri cataloghi (più di 1000 codici pronti per il montaggio) c'è sempre bisogno di guarnizioni speciali. Vi consigliamo 2 soluzioni per il "fai da te"!



3394920

Cesoie per guarnizioni



Soluzione **A**

Soluzione **B**



3394909

Saldatrice per guarnizioni

3186899

Angolare per guarnizioni (1 x ogni angolo)



3180155

Adesivo speciale per Guarnizioni "con inserto magnetico"



3180154

Adesivo universale



Il nostro consiglio

- Acquistate le guarnizioni in lunghezza standard (con angolare ) o di lunghezza | 200, 220, 250 cm)
- Tagliate, incollate o saldate voi stessi le guarnizioni speciali

www.lfcatering.com

Guarnizioni per "fai da te"

3394920 Cesoie per guarnizioni
• Taglio a 45°



3394909 Saldatrice a caldo per guarnizioni
230 V / 300°C
Temperatura regolabile fino a 300°C



3180154 Adesivo universale 20 ml
Per gomma, plastica,
legno, metallo,
ceramica, cartone



3180155 Adesivi speciale 20 gr
Per guarnizioni con
inserto magnetico.



3186899 Inserto angolare
1 inserto angolare per
ogni punto di unione



3186767 Guarnizione a incastro
lunghezza = 200 cm
• con inserto magnetico
• 4 punti di saldatura
• colore nero

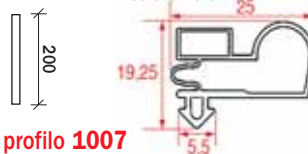

profilo 1007

3186078 Guarnizione a incastro
lunghezza = 250 cm
• senza inserto magnetico
• 4 punti di saldatura
• colore grigio



profilo 1026

3186848 Guarnizione a L 60x130 cm
• con inserto magnetico
• mezzo bordo corto
• colore bianco
Tagliare il lato della
lunghezza richiesta
Vantaggi: solo 2 punti di
saldatura



Per 1 guarnizione:
1 paio =
1 per sinistra +
1 per destra

profilo 2001

3186849 Guarnizione a L 60x130 cm
• con inserto magnetico
• mezzo bordo lungo
• colore bianco
Tagliare il lato della
lunghezza richiesta
Vantaggi: solo 2 punti di
saldatura



Per 1 guarnizione:
1 paio =
1 per sinistra +
1 per destra

profilo 2002

3186871 Guarnizione a L 100x200 cm
• con inserto magnetico
• bordo più corto
Tagliare il lato della
lunghezza richiesta
Vantaggi: solo 2 punti
di saldatura



Per 1 guarnizione:
1 paio =
1 per sinistra +
1 per destra

profilo 2001

3186872 Guarnizione a L 100x200 cm
• con inserto magnetico
• bordo lungo
Tagliare il lato della
lunghezza richiesta
Vantaggi: solo 2
punti di saldatura



Per 1 guarnizione:
1 paio =
1 per sinistra +
1 per destra

profilo 2002

3186867 Guarnizione mezzo bordo
lunghezza = 200 cm
• con inserto magnetico
• colore grigio
• 4 punti di saldatura

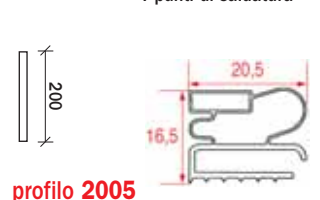

profilo 2005

3186870 Guarnizione a incastro
lunghezza = 200 cm
• con inserto magnetico
• colore grigio
• 4 punti di saldatura

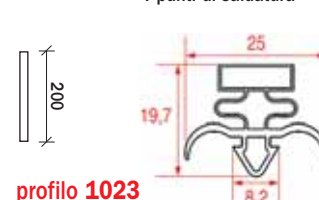

profilo 1023

3186874 Guarnizione a incastro
lunghezza = 200 cm
• con inserto magnetico
• colore grigio
• 4 punti di saldatura



profilo 1001

3186875 Guarnizione mezzo bordo
lunghezza = 200 cm
• con inserto magnetico
• colore grigio
• 4 punti di saldatura

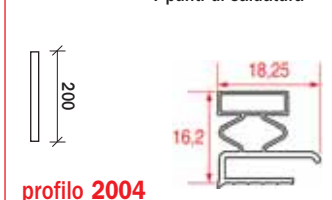

profilo 2004

3186876 Guarnizione a incastro
lunghezza = 200 cm
• con inserto magnetico
• colore grigio
• 4 punti di saldatura

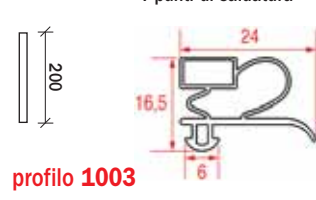

profilo 1003

3186877 Guarnizione a incastro
lunghezza = 200 cm
• con inserto magnetico
• colore grigio
• 4 punti di saldatura

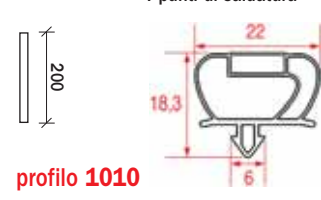

profilo 1010

3186880 Guarnizione a incastro
lunghezza = 200 cm
• senza inserto magnetico
• colore grigio
• 4 punti di saldatura



profilo 1027

3186711 Guarnizione a incastro
lunghezza = 200 cm
• senza inserto magnetico
• colore grigio
• 4 punti di saldatura

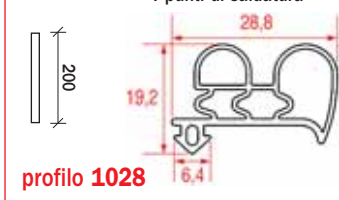

profilo 1028

3186777 Guarnizione a incastro
lunghezza = 250 cm
• con inserto magnetico
• colore bianco
• 4 punti di saldatura



profilo 1018

3186778 Guarnizione a incastro
lunghezza = 250 cm
• con inserto magnetico
• colore bianco
• 4 punti di saldatura

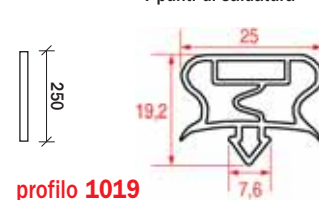

profilo 1019

3186779 Guarnizione a incastro
lunghezza = 250 cm
• con inserto magnetico
• colore bianco
• 4 punti di saldatura

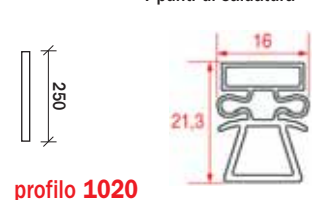

profilo 1020

3186824 Guarnizione a incastro
lunghezza = 220 cm
• con inserto magnetico
• colore grigio
• 4 punti di saldatura



profilo 1024

Problems with special gaskets?

The best solution is to “do-it-yourself”!

Even if we offer a wide range of gaskets (more than 1000 ready-to-use items in our catalogue) you will always need special gaskets.

We recommend 2 “do-it-yourself” solutions!



3394920
Shears for gaskets



Solution A

Solution B



3394909
Heated welding machine for gaskets



3186899
Elbow inserts (1 x each corner)



3180155
Special adhesive for gaskets “with magnetic insert”



3180154
Universal adhesive



Our suggestion

- Buy standard length gaskets (elbow \square or 200, 220, 250 cm long | elements)
- Cut, glue or weld your special gaskets by yourself

www.lfcatering.com

“Do-it-yourself” gaskets

3394920 Shears for gaskets
• 45° angle cut



3394909 Warm welding machine for gaskets
230 V / 300°C
Adjustable temperature up to 300°C



3180154 Universal adhesive 20 ml
For rubber – plastic –
wood – metal
ceramics – cardboard



3180155 Special adhesive 20 gr
For gaskets with
magnetic insert



3186899 Angle inserts
1 angle insert for
each splice



3186767 Snap-in gasket
length = 200 cm
• with magnetic insert
• color black
• 4 welds

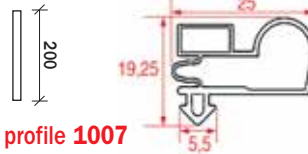

profile 1007

3186078 Snap-in gasket
length = 250 cm
• without magnetic insert
• color grey
• 4 welds



profile 1026

3186848 L - gasket 60x130 cm
• with magnetic insert
• short Middle-edged
• color white
Cut to the required length
Advantage: 2 welds only

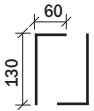

For 1 gasket:
1 pair =
1 for left +
1 for right



profile 2001

3186849 L - gasket 60x130 cm
• with magnetic insert
• long Middle-edged
• color white
Cut to the required length
Advantage: 2 welds only

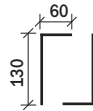

For 1 gasket:
1 pair =
1 for left +
1 for right

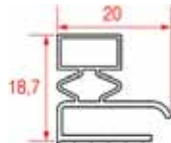

profile 2002

3186871 L - gasket 100x200 cm
• with magnetic insert
• short edged
Cut to the required length
Advantage: 2 welds only

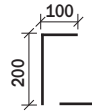

For 1 gasket:
1 pair =
1 for left +
1 for right

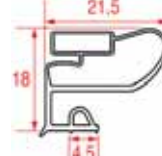

profile 2001

3186872 L - gasket 100x200 cm
• with magnetic insert
• long edged
Cut to the required length
Advantage: 2 welds only

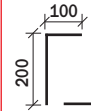

For 1 gasket:
1 pair =
1 for left +
1 for right

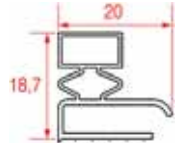

profile 2002

3186867 Middle-edged gasket
length = 200 cm
• with magnetic insert
• color grey
• 4 welds



profile 2005

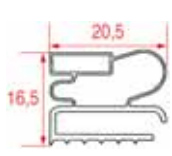

3186870 Snap-in gasket
length = 200 cm
• with magnetic insert
• color grey
• 4 welds



profile 1023



3186874 Snap-in gasket
length = 200 cm
• with magnetic insert
• color grey
• 4 welds



profile 1001

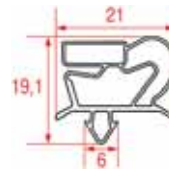

3186875 Middle-edged gasket
length = 200 cm
• with magnetic insert
• color grey
• 4 welds



profile 2004

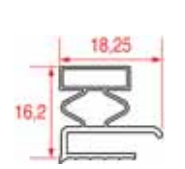

3186876 Snap-in gasket
length = 200 cm
• with magnetic insert
• color grey
• 4 welds



profile 1003

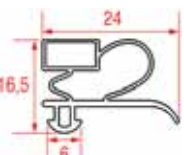

3186877 Snap-in gasket
length = 200 cm
• without magnetic insert
• color grey
• 4 welds

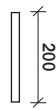

profile 1010

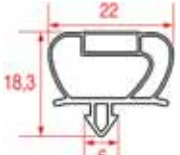

3186880 Snap-in gasket
length = 200 cm
• without magnetic insert
• color grey
• 4 welds



profile 1027

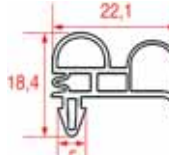

3186711 Snap-in gasket
length = 200 cm
• without magnetic insert
• color grey
• 4 welds

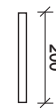

profile 1028

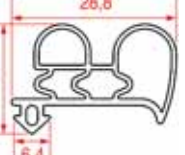

3186777 Snap-in gasket
length = 250 cm
• with magnetic insert
• color grey
• 4 welds

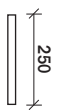

profile 1018

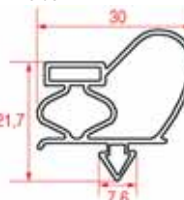

3186778 Snap-in gasket
length = 250 cm
• with magnetic insert
• color grey
• 4 welds

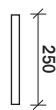

profile 1019

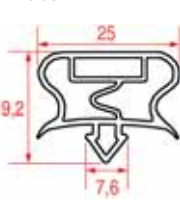

3186779 Snap-in gasket
length = 250 cm
• with magnetic insert
• color grey
• 4 welds

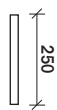

profile 1020

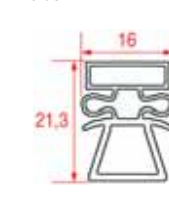

3186824 Snap-in gasket
length = 220 cm
• with magnetic insert
• color white
• 4 welds



profile 1024



Problem Spezialdichtungen?

Die beste Lösung ist "Selbstbau"!

Trotz unseres großen Angebotes an Dichtungen (über 1000 fertige Rahmen) benötigen Sie immer wieder Spezialdichtungen. Wir empfehlen 2 Lösungen für "Selbstbau"!



3394920

Schere für
dichtungen



Lösung
A

Lösung
B



3394909

Wärmeschweißgerät

3186899

Winkleinsätze
(1 x je Ecke)



3180155

Spezialkleber für
Dichtungen "mit
Magneinsatz"



3180154

Universalkleber



Unser Vorschlag

- Sie kaufen Dichtungen in Standardstücken (Winklelemente  oder 200, 220, 250 cm Länge |)
- Sie schneiden - kleben oder schweißen selbst Ihre Spezialdichtung

www.lfcatering.de • www.lfcatering.ch

Dichtungen für "Selbstbau"

3394920 Schere für Dichtungen
• 45° Schnitt



3394909 Wärmeschweißgerät für Dichtungen
230 V / 300°C
Temperatur einstellbar bis 300 °C



3180154 Universalkleber 20 ml
Für Gummi - Plastik - Holz
Metall - Keramik- Karton



3180155 Spezialkleber 20 gr.
Für Dichtungen mit
Magneiteinsatz



3186899 Winkeleinsätze
je 1 Winkeleinsatz für
jede Klebstelle



3186767 Steckdichtung
Länge = 200 cm
• Mit Magneteinsatz
• 4 Schweißstellen
• Farbe schwarz

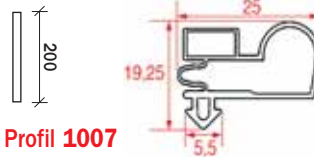

Profil 1007

3186078 Steckdichtung
Länge = 250 cm
• ohne Magneteinsatz
• 4 Schweißstellen
• Farbe grau



Profil 1026

3186848 L - Dichtung 60x130 cm
• mit Magneteinsatz
• halber Rand kurz
• Farbe weiß
Seiten in gewünschter
Länge schneiden
Vorteil: nur 2 Schweißstellen

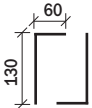

Für 1 Dichtung:
1 Paar =
1 für Links +
1 für Rechts



Profil 2001

3186849 L - Dichtung 60x130 cm
• Mit Magneteinsatz
• halber Rand lang
• Farbe weiß
Seiten in gewünschter
Länge schneiden
Vorteil: nur 2 Schweißstellen

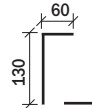

Für 1 Dichtung:
1 Paar =
1 für Links +
1 für Rechts

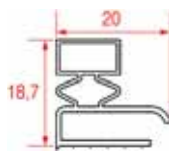

Profil 2002

3186871 L - Dichtung 100x200 cm
• mit Magneteinsatz
• kurzer Rand
• Seiten in gewünschter
Länge schneiden
Vorteil: nur 2 Schweißstellen

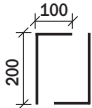

Für 1 Dichtung:
1 Paar =
1 für Links +
1 für Rechts

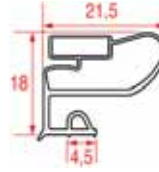

Profil 2001

3186872 L - Dichtung 100x200 cm
• mit Magneteinsatz
• Langer Rand
• Seiten in gewünschter
Länge schneiden
Vorteil: nur 2
Schweißstellen

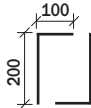

Für 1 Dichtung:
1 Paar =
1 für Links +
1 für Rechts

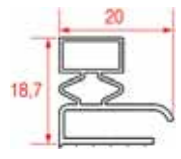

Profil 2002

3186867 Dichtung mit Halbrahmen
Länge = 200 cm
• Mit Magneteinsatz
• Farbe Grau
• 4 Schweißstellen

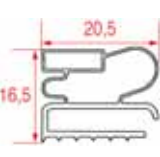
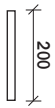

Profil 2005

3186870 Steckdichtung
Länge = 200 cm
• Mit Magneteinsatz
• Farbe Grau
• 4 Schweißstellen

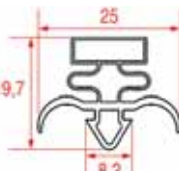
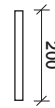

Profil 1023

3186874 Steckdichtung
Länge = 200 cm
• Mit Magneteinsatz
• Farbe Grau
• 4 Schweißstellen

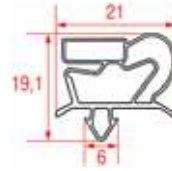
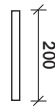

Profil 1001

3186875 Dichtung mit Halbrahmen
Länge = 200 cm
• Mit Magneteinsatz
• Farbe grau
• 4 Schweißstellen

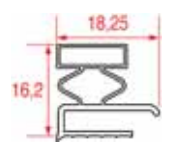
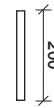

Profil 2004

3186876 Steckdichtung
Länge = 200 cm
• Mit Magneteinsatz
• Farbe grau
• 4 Schweißstellen

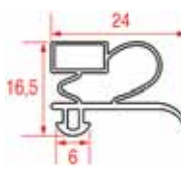
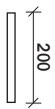

Profil 1003

3186877 Steckdichtung
Länge = 200 cm
• Mit Magneteinsatz
• Farbe grau
• 4 Schweißstellen

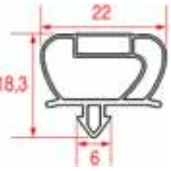
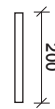

Profil 1010

3186880 Steckdichtung
Länge = 200 cm
• ohne Magneteinsatz
• Farbe grau
• 4 Schweißstellen

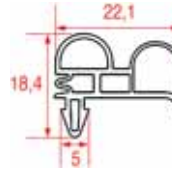
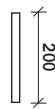

Profil 1027

3186711 Steckdichtung
Länge = 200 cm
• ohne Magneteinsatz
• Farbe grau
• 4 Schweißstellen

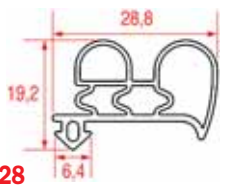
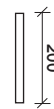

Profil 1028

3186777 Steckdichtung
Länge = 250 cm
• Mit Magneteinsatz
• Farbe Grau
• 4 Schweißstellen

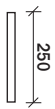

Profil 1018

3186778 Steckdichtung
Länge = 250 cm
• Mit Magneteinsatz
• Farbe Grau
• 4 Schweißstellen

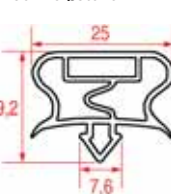
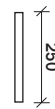

Profil 1019

3186779 Steckdichtung
Länge = 250 cm
• Mit Magneteinsatz
• Farbe Grau
• 4 Schweißstellen



Profil 1020

3186824 Steckdichtung
Länge = 220 cm
• Mit Magneteinsatz
• Farbe weiß
• 4 Schweißstellen

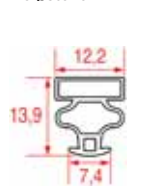

Profil 1024

¿Problemas con los burletes especiales?

¡La solución mejor es “hazlo tú mismo”!

A pesar del gran surtido de burletes en nuestros catálogos (más de 1000 códigos listos para el montaje) siempre se necesitan burletes especiales. ¡Le aconsejamos 2 soluciones de “trabajo manual”!



3394920
Tijera para burletes



Solución A

Solución B



3394909
Soldadora para burletes



3186899
Angular para burletes (1 para cada ángulo)



3180155
Adhesivo especial para burletes “con inserción magnética”



3180154
Adhesivo universal



Nuestro consejo

- Compre sus burletes en la longitud estándar (con angular  o de longitud | 200, 220, 250 cm)
- Corte, pegue o suelde por su cuenta los burletes especiales

www.ifcatering.es

Burletes para "hazlo tú mismo"

3394920 Tijera para burletes
• Corte a 45°



3394909 Soldadora con calor para burletes
230V / 300°C
Temperatura ajustable hasta 300°C



3180154 Adhesivo universal 20 ml
Para goma, plástico,
madera, metal,
cerámica, cartón



3180155 Adhesivo especial 20gr
Para burletes con
inserción magnética



3186899 Inserción angular
1 inserción para
cada punto de unión



3186767 Burlete de encaje
longitud = 200 cm
• con inserción magnética
• 4 puntos de soldadura
• color negro

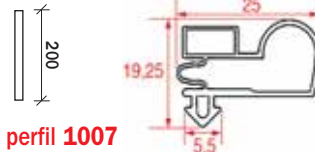

perfil 1007

3186078 Burlete de encaje
longitud = 250 cm
• sin inserción magnética
• 4 puntos de soldadura
• color gris



perfil 1026

3186848 Burlete en L 60x130 cm
• con inserción magnética
• medio borde corto
• color blanco
Cortar el lado en la
longitud deseada
Ventajas: sólo 2 puntos
de soldadura

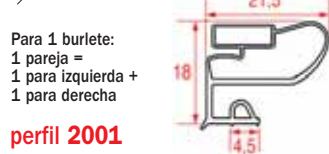

Para 1 burlete:
1 pareja =
1 para izquierda +
1 para derecha

perfil 2001

3186849 Burlete en L 60x130 cm
• con inserción magnética
• medio borde largo
• color blanco
Cortar el lado en la
longitud deseada
Ventajas: sólo 2 puntos
de soldadura



Para 1 burlete:
1 pareja =
1 para izquierda +
1 para derecha

perfil 2002

3186871 Burlete en L 100x200 cm
• con inserción magnética
• borde más corto
Cortar el lado en la
longitud deseada
Ventajas: sólo 2 puntos
de soldadura

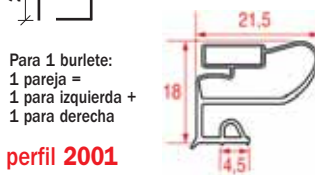

Para 1 burlete:
1 pareja =
1 para izquierda +
1 para derecha

perfil 2001

3186872 Burlete en L 100x200 cm
• con inserción magnética
• borde largo
Cortar el lado en la
longitud deseada
Ventajas: sólo 2 puntos
de soldadura

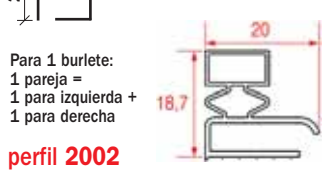

Para 1 burlete:
1 pareja =
1 para izquierda +
1 para derecha

perfil 2002

3186867 Burlete de medio borde
longitud = 200 cm
• con inserción magnética
• 4 puntos de soldadura
• color gris



perfil 2005

3186870 Burlete de encastre
longitud = 200 cm
• con inserción magnética
• 4 puntos de soldadura
• color gris



perfil 1023

3186874 Burlete de encastre
longitud = 200 cm
• con inserción magnética
• 4 puntos de soldadura
• color gris



perfil 1001

3186875 Burlete de medio borde
longitud = 200 cm
• con inserción magnética
• 4 puntos de soldadura
• color gris

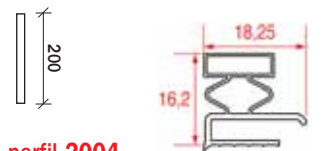

perfil 2004

3186876 Burlete de encastre
longitud = 200 cm
• con inserción magnética
• 4 puntos de soldadura
• color gris

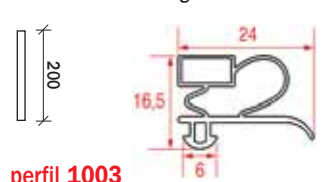

perfil 1003

3186877 Burlete de encastre
longitud = 200 cm
• con inserción magnética
• 4 puntos de soldadura
• color gris

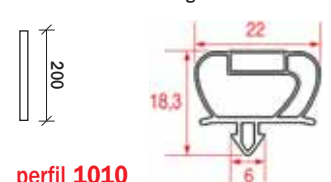

perfil 1010

3186880 Burlete de encastre
longitud = 200 cm
• sin inserción magnética
• 4 puntos de soldadura
• color gris



perfil 1027

3186711 Burlete de encastre
longitud = 200 cm
• sin inserción magnética
• 4 puntos de soldadura
• color gris

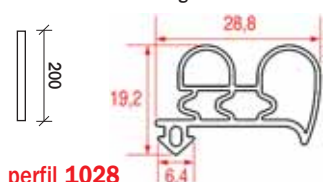

perfil 1028

3186777 Burlete de encastre
longitud = 250 cm
• con inserción magnética
• 4 puntos de soldadura
• color blanco

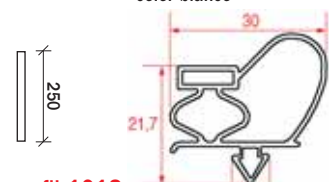

perfil 1018

3186778 Burlete de encastre
longitud = 250 cm
• con inserción magnética
• 4 puntos de soldadura
• color blanco

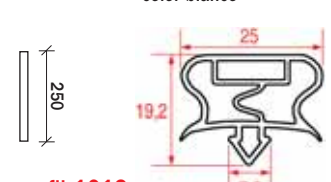

perfil 1019

3186779 Burlete de encastre
longitud = 250 cm
• con inserción magnética
• 4 puntos de soldadura
• color blanco



perfil 1020

3186824 Burlete de encastre
longitud = 220 cm
• con inserción magnética
• 4 puntos de soldadura
• color gris



perfil 1024

Conoscete già la nostra vasta proposta di ricambi?

Are you already informed on our wide offer?

Kennen Sie schon unser großes Sortiment?

¿Esta informado ya de nuestra amplia oferta?





New





Spare parts for Professional kitchens, Espresso coffee machines, Commercial refrigeration and Bar equipment

ITALIA

LF spa • via Voltri, 80 • 47522 Torre del Moro • Cesena (FC)
Tel. +39 0547 34 11 11 • Fax +39 0547 34 11 10
www.lfcatering.com • www.lfricambi724.mobi • e-mail: info@lfcatering.com

DEUTSCHLAND

LF GmbH • Junkersstrasse, 1 • D-82178 Puchheim • München
Tel. +49 89 89 45 78 66 • Fax +49 89 89 45 78 88
www.lfcatering.de • www.lfersatzteile724.mobi • e-mail: info@lfcatering.de

SCHWEIZ

LF GmbH Verkaufsbüro • Sennweidstrasse, 45 • CH-6312 Steinhausen
Tel. +41 41 760 15 80-1 • Fax +41 41 760 15 85
www.lfcatering.ch • www.lfersatzteilech724.mobi • e-mail: info@lfcatering.ch

ESPAÑA

LF oficina de venta • Calle Ciudad Real, 10 • 45517 Escalonilla (Toledo)
Tel. +34 925 75 83 23 • Fax +34 925 75 82 09
www.lfcatering.es • www.lfrepuestos724.mobi • e-mail: info@lfcatering.es

RUSSIA

000 LF • ul, Anatoliya Zhivova, 8 - office 1 • 123100 Moscow
Tel. +7 499 259 85 75 • Fax +7 499 259 85 75
www.lfcatering.ru • www.lfspareparts724.mobi • e-mail: russia@lfcatering.com

CHINA

LF China • Room 102, House 8, Lane 725, Mao Tai Rd. Changning Dist. • 200336 Shanghai
Tel. +862 133 53 66 31 • Fax. +862 133 53 66 32
www.lfcatering.com • www.lfspareparts724.mobi • e-mail: china@lfcatering.com